

2021

PRODUCT GUIDE

NVP
NATIONAL VINYL
PRODUCTS





PRIVACY FENCE
in Weathered Aspen and White Trim

Welcome to the NVP 2021 Product Guide

NVP is pleased to provide our updated 2021 Product Guide. This guide has been formatted to help you find the fencing material and resources you are looking. Inside you will also find announcements and new products being offered for the coming year. We look forward to providing you the best quality material and service in the industry.

The 2021 Product Guide contains all the standard profiles, colors and lengths that NVP manufactures. If you do not see what you are looking for, please contact your sales representative.

SPECIAL ORDER DETAILS:

Special orders are considered to be any profile, color or length not included in the Product Guide or found on a standard pricing sheet. NVP will work with you to meet your custom size, color, or profile needs. These items may be subject to minimum order requirements and extended lead times. Contact your sales representative for additional information, pricing, and timing for these products.

Come visit us online!

Our website is full of helpful information whether you are the homeowner, designer, contractor, distributor or just looking for ideas.



Visit our website to for the following resources:

PHOTOS

Download hi-resolution images to show a wide verity of fence styles and colors.

INSTALLATION GUIDE

Detailed installation guides are available for a variety of fencing styles.

WARRANTY

Download and print off warranties registration and literature for yourself or your customer.

CERTIFICATIONS

Looking for a certain fence or railing certification? Check out the website or give us a call

TESTING DOCUMENTATION

Our website has you covered with testing results for applicable standards and more.

MARKETING MATERIALS

We offer an array of marketing materials to better help your business grow.

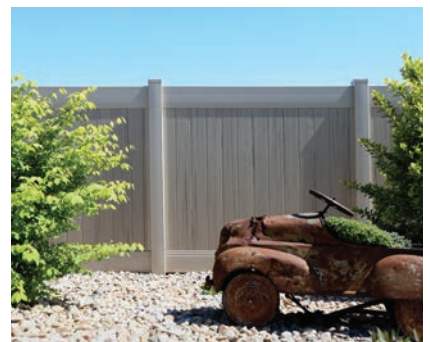
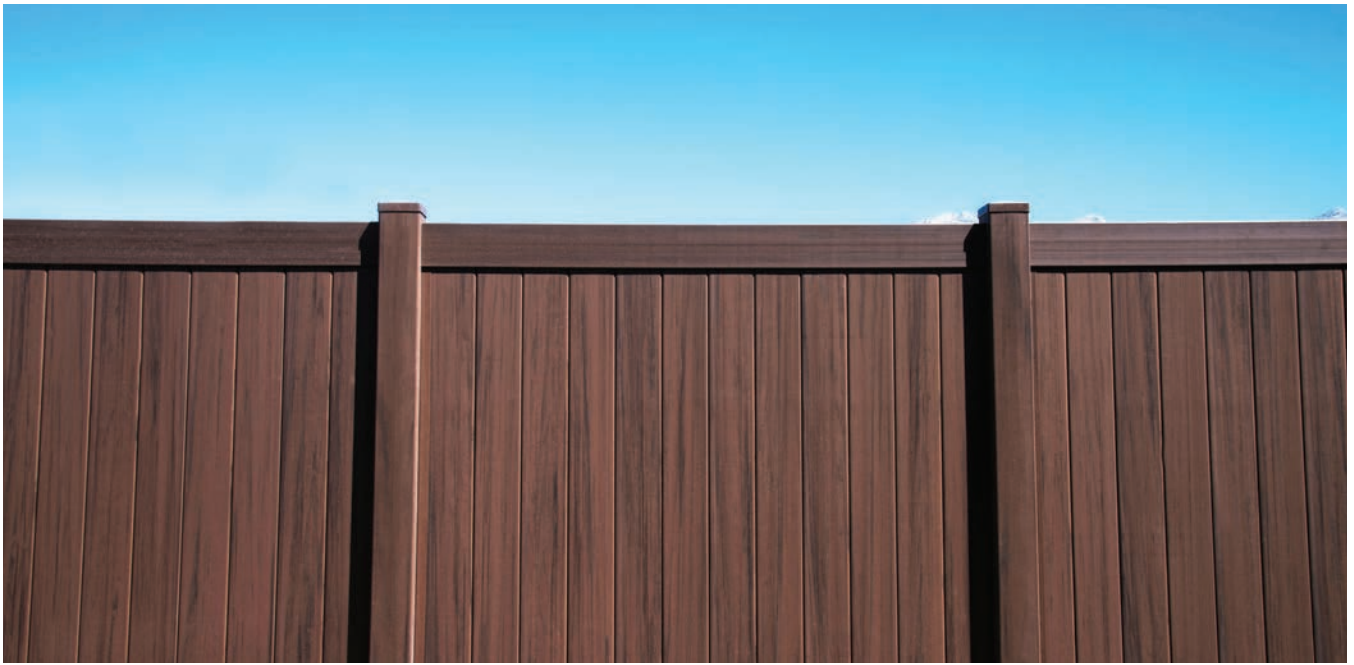

↓ **DOWNLOAD OUR FREE HI-RESOLUTION FENCE PHOTOS**

nvpfence.com/gallery

Coast to Coast

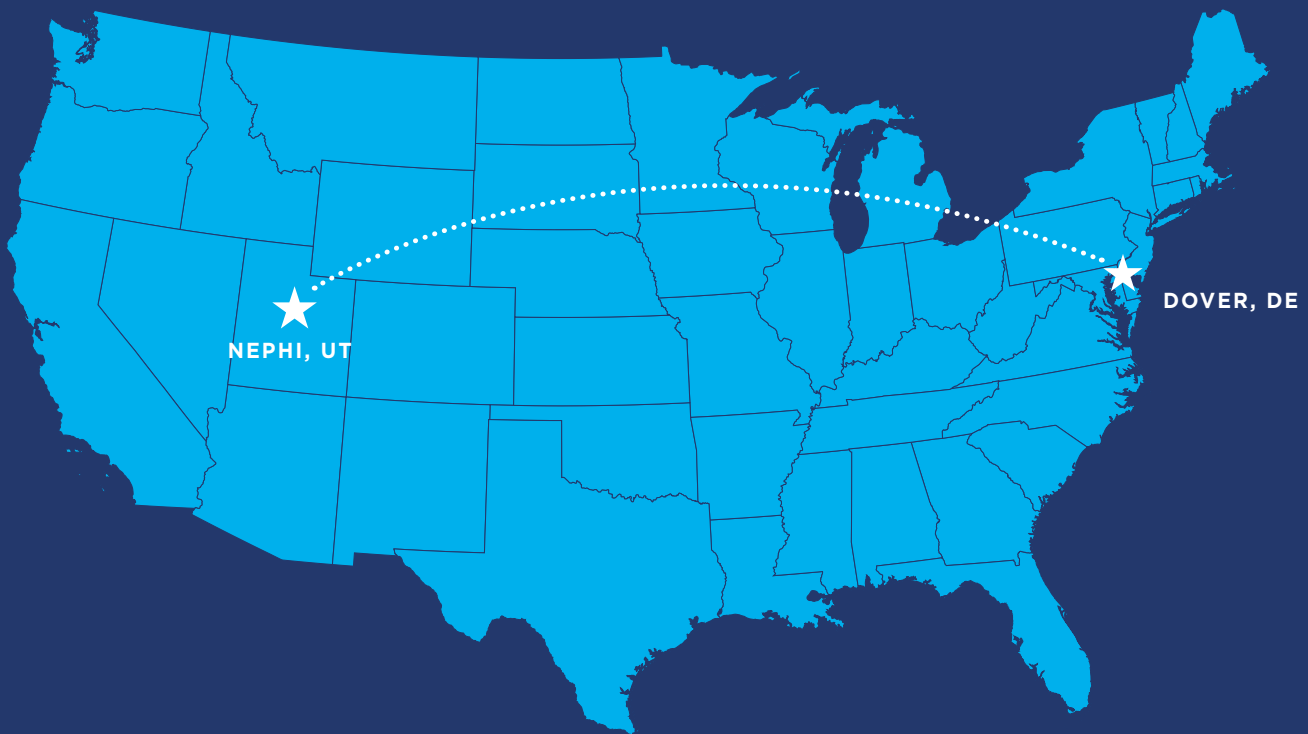

New Plant

NEW PLANT, DOVER, DE

We are pleased to announce that our Dover, Delaware plant is open for business! During these last 12 months, while the fence and rail industry has seen unprecedented growth and demand, our team has been working through setbacks, construction delays, and COVID-19 detained equipment to get this plant online. This new location will allow us to better meet and exceed your production needs all across the country with additional capacity as we begin this new year. We look forward to helping you grow with us as we expand with you in the years to come.

Announcements

INTRODUCING AN ALL-NEW RAIL SYSTEM.

Look for the 'Railing System' logo on the following pages for profiles that apply.



TIMBERLAND SPECIAL ORDERS

We now sell fence by the section in all our Timberland Colors to make special orders easier for you!

END VIEW OF HOW THE MATERIAL WILL BE PACKAGED

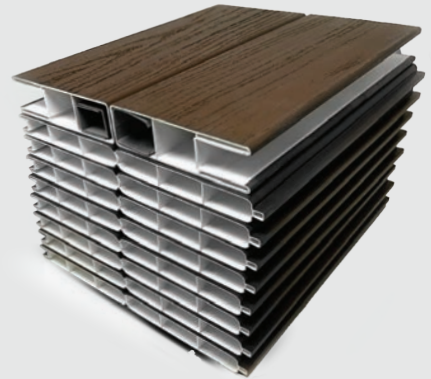

TIMBERLAND FENCE SECTION DETAILS BEGIN ON PAGE

#61

PRIVACY FENCE
Clay and Textured Driftwood



Index

PRODUCT GUIDE

Pickets: pgs. 11-18

Pickets

Posts: pgs. 19-31

Posts

Rails: pgs. 33-49

Rails

T&G Panel: pgs. 51-58

T&G Panel

U-Channel: pgs. 59, 60

U-Channel

Accessories: pgs. 65-84

Accessories



CLOSED PICKET
in Tan

Pickets

pgs. 11-18

Pickets

0.875" X 1.5" X 0.070" PICKET

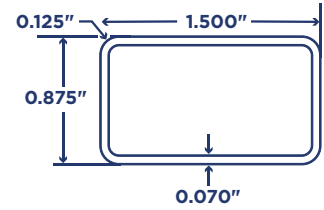

ACCESSORIES

Picket cap accessories are available in this size.
See pages 71-73 in the Accessories Section for picket cap details.

Pickets

AVAILABLE COLORS:

Standard Color

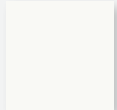

White



Tan



Clay

AVAILABLE LENGTH & COLORS

	Color	Length	Bundle Quantity	Part #
Standard Color	WHITE	192"	30	PK87515W192-P
		192"	280	PK87515W192
	TAN	192"	30	PK87515T192-P
		192"	280	PK87515T192
	CLAY	192"	30	PK87515C192-P

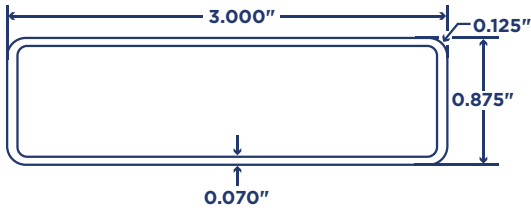

Pickets

0.875" X 3" X 0.070" PICKET

ACCESSORIES

Picket cap accessories are available in this size. See pages 71-73 in the Accessories Section for picket cap details.

AVAILABLE LENGTH & COLORS

	Color	Length	Bundle Quantity	Part #
Standard Color	WHITE	192"	156	PK8753W192
		192"	30	PK8753W192-P
	TAN	192"	156	PK8753T192
		192"	30	PK8753T192-P
	CLAY	192"	156	PK8753C192-P
	SLATE GRAY	192"	156	PK8753G192
		192"	30	PK8753G192-P
	Timberland Series	WEATHERED ASPEN	192"	156
192"			30	PK8753W192-W-P
DRIFTWOOD		192"	156	PK8753C192-W
		192"	30	PK8753C192-W-P
COASTAL CEDAR		192"	156	PK8753CC192
		192"	30	PK8753CC192-P
DARK WALNUT		192"	156	PK8753DW192
		192"	30	PK8753DW192-P
DARK SEQUOIA		192"	156	PK8753DS192
		192"	30	PK8753DS192-P

AVAILABLE COLORS:

Standard Color

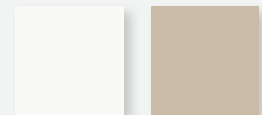

White Tan



Clay Slate Gray

Timberland Series

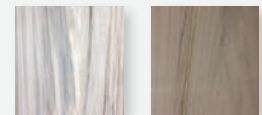

Weathered Aspen Driftwood

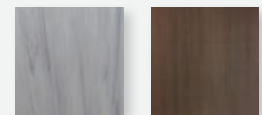

Coastal Cedar Dark Walnut



Dark Sequoia

Pickets

0.875" X 6" X 0.060" PICKET

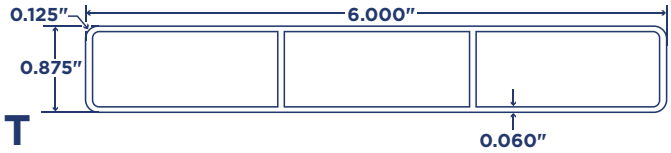

ACCESSORIES

Picket cap accessories are available in this size. See pages 71-73 in the Accessories Section for picket cap details.

Pickets

AVAILABLE COLORS:

Standard Color

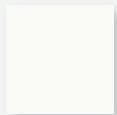

White



Tan



Clay



Slate Gray

Timberland Series

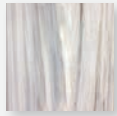

Weathered Aspen

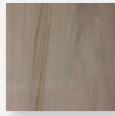

Driftwood

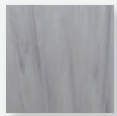

Coastal Cedar

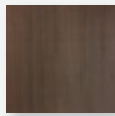

Dark Walnut



Dark Sequoia

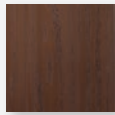

Textured Dark Sequoia

AVAILABLE LENGTH & COLORS

	Color	Length	Bundle Quantity	Part #	
Standard Color	WHITE	144"	104	PK8756W144	
		192"	104	PK8756W192	
	TAN	144"	104	PK8756T144	
		192"	104	PK8756T192	
	CLAY	144"	104	PK8756C144	
		192"	104	PK8756C192	
	SLATE GRAY	144"	104	PK8756G144	
	Timberland Series	WEATHERED ASPEN	144"	104	PK8756W144-W
		DRIFTWOOD	144"	104	PK8756C144-W
		COASTAL CEDAR	144"	104	PK8756CC144
DARK WALNUT		144"	104	PK8756DW144	
		192"	104	PK8756DW192	
DARK SEQUOIA		72"	104	PK8756DS72	
		144"	104	PK8756DS144	
		192"	104	PK8756DS192	
TEXTURED DARK SEQUOIA		72"	104	PK8756DS72-E	

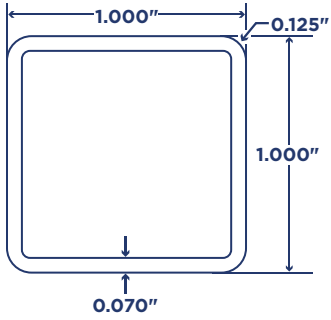

Pickets

1" X 1" X 0.070" PICKET

ACCESSORIES

Picket cap accessories are available in this size.
See pages 71-73 in the Accessories Section for picket cap details.

AVAILABLE LENGTH & COLORS

	Color	Length	Bundle Quantity	Part #
Standard Color	WHITE	192"	210	PK1W192
		192"	30	PK1W192-P
	TAN	192"	210	PK1T192
		192"	30	PK1T192-P
	CLAY	192"	30	PK1C192-P

AVAILABLE COLORS:

Standard Color

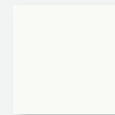

White



Tan



Clay

Pickets

1.375" X 1.375" X 0.070" PICKET

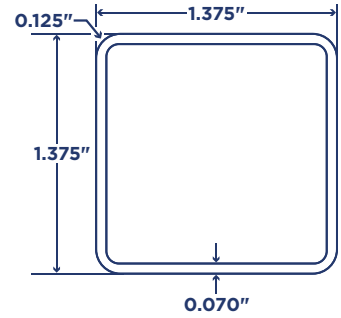

ACCESSORIES

Picket cap accessories are available in this size. See pages 71-73 in the Accessories Section for picket cap details.

AVAILABLE COLORS:

Standard Color

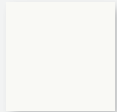

White



Tan



Clay

AVAILABLE LENGTH & COLORS

	Color	Length	Bundle Quantity	Part #
Standard Color	WHITE	32"	704	PK1375W32-704
		192"	704	PK1375W192-704
		192"	240	PK1375W192
		192"	30	PK1375W192-P
	TAN	192"	240	PK1375T192
		192"	30	PK1375T192-P
	CLAY	192"	30	PK1375C192-P

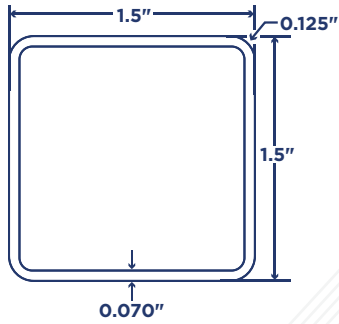

Pickets

1.5" X 1.5" X 0.070" PICKET

ACCESSORIES



Picket cap accessories are available in this size.
See pages 71-73 in the Accessories Section for picket cap details.



AVAILABLE LENGTH & COLORS

	Color	Length	Bundle Quantity	Part #
Standard Color	WHITE	32"	600	PK1515W32
		192"	130	PK1515W192
		192"	30	PK1515W192-P
	TAN	32"	600	PK1515T32
		192"	130	PK1515T192
		192"	30	PK1515T192-P
CLAY	192"	30	PK1515C192-P	

AVAILABLE COLORS:

Standard Color

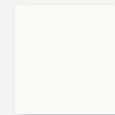

White



Tan



Clay

Pickets

1.75" X 1.75" X 0.070" PICKET

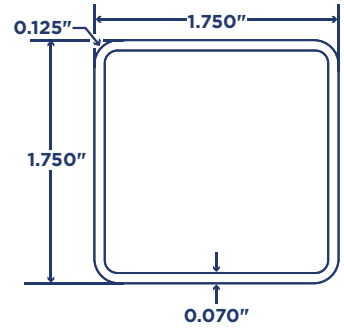

ACCESSORIES

Picket cap accessories are available in this size. See pages 71-73 in the Accessories Section for picket cap details.

Pickets

AVAILABLE COLORS:

Standard Color

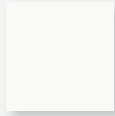

White

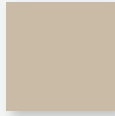

Tan

AVAILABLE LENGTH & COLORS

	Color	Length	Bundle Quantity	Part #
Standard Color	WHITE	192"	130	PK175W192
		192"	30	PK175W192-P
	TAN	192"	130	PK175T192
		192"	30	PK175T192-P

Posts

pgs. 13-22

Posts

3.25" X 3.25" X .120" WALL POSTS

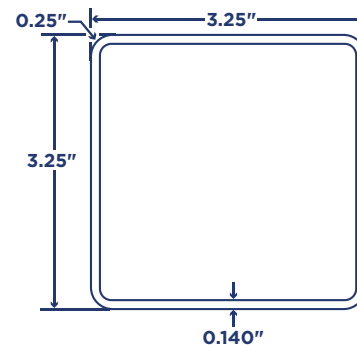

AVAILABLE COLORS:

Standard Color

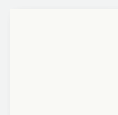

White



Tan

AVAILABLE LENGTH & COLORS

	Color	Length	Bundle Quantity	Part #
Standard Color	WHITE	192"	98	PS325-120W192
	TAN	192"	98	PS325-120T192

Posts

4" X 4" X .110" WALL POSTS

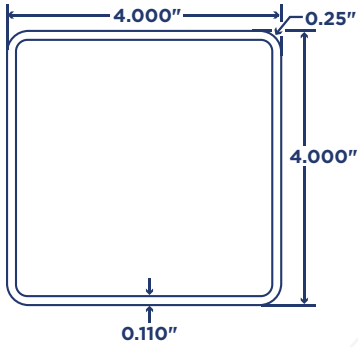

ACCESSORIES



Metal inserts and towers are available for 4" x 4" posts. See pages 77-80 in the Accessories Section for insert details.



AVAILABLE LENGTH & COLORS

	Color	Length	Bundle Quantity	Part #
Standard Color	WHITE	194.5"	55	PS44-110W194.5
	TAN	194.5"	55	PS44-110W194.5

AVAILABLE COLORS:

Standard Color

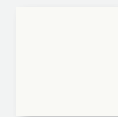

White



Tan

Posts

Posts

4" X 4" X .140" WALL POSTS

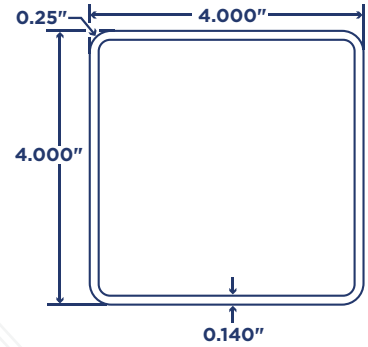

ACCESSORIES



Metal inserts and towers are available for 4" x 4" posts. See pages 77-80 in the Accessories Section for insert details.

AVAILABLE COLORS:

Standard Color

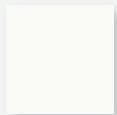

White



Tan



Clay



Slate Gray

Timberland Series

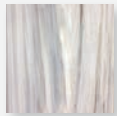

Weathered Aspen

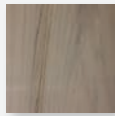

Driftwood

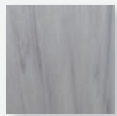

Coastal Cedar

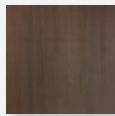

Dark Walnut



Dark Sequoia

AVAILABLE LENGTH & COLORS

	Color	Length	Bundle Quantity	Part #
Standard Color	WHITE	72"	55	PS44-140W72
		194.5"	55	PS44-140W194
	TAN	72"	55	PS44-140T72
		194.5"	55	PS44-140T194
	CLAY	72"	55	PS44-140C72
		194.5"	55	PS44-140C194
	SLATE GRAY	72"	55	PS44-140G72
		194.5"	55	PS44-140G194
Timberland Series*	WEATHERED ASPEN	72"	55	PS44-140W72-W
		194.5"	55	PS44-140W194-W
	DRIFTWOOD	72"	55	PS44-140C72-W
		194.5"	55	PS44-140C194-W
	COASTAL CEDAR	72"	55	PS44-140CC72
		194.5"	55	PS44-140CC194
	DARK WALNUT	72"	55	PS44-140DW72
		194.5"	55	PS44-140DW194
	DARK SEQUOIA	72"	55	PS44-140DS72
		194.5"	55	PS44-140DS194

*Timberland Series colors can also be purchased by the piece.

Posts

4" X 4" X .165" WALL POSTS

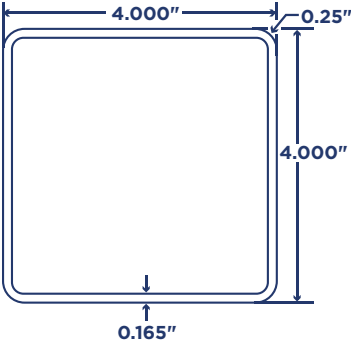

ACCESSORIES

Our 4" x 4" posts have a variety of caps to choose from. See pages 77-80 in the Accessories Section for insert details.

AVAILABLE LENGTH & COLORS

	Color	Length	Bundle Quantity	Part #
Standard Color	WHITE	194.5"	55	PS44-165W194
	TAN	194.5"	55	PS44-165T194
	CLAY	194.5"	55	PS44-165C194

AVAILABLE COLORS:

Standard Color

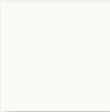

White



Tan



Clay

Posts

Posts

5" X 5" X .135" WALL POSTS

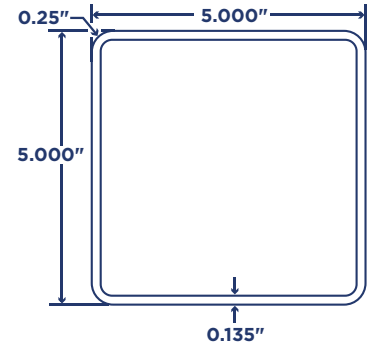

ACCESSORIES



Metal inserts and towers are available for 5" x 5" posts. See pages 77-80 in the Accessories Section for insert details.

AVAILABLE COLORS:

Standard Color

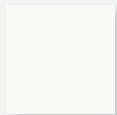

White

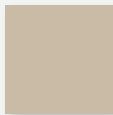

Tan



Clay



Slate Gray

AVAILABLE LENGTH & COLORS

	Color	Length	Bundle Quantity	Part #
Standard Color	WHITE	60"	54	PS55-135W60
		72"	54	PS55-135W72
		78"	54	PS55-135W78
		84"	54	PS55-135W84
		96"	54	PS55-135W96
		108"	54	PS55-135W108
		192"	54	PS55-135W192
	TAN	60"	54	PS55-135T60
		72"	54	PS55-135T72
		78"	54	PS55-135T78
		84"	54	PS55-135T84
		96"	54	wPS55-135T96
		108"	54	PS55-135T108
		192"	54	PS55-135T192
	CLAY	96"	54	PS55-135C96
		108"	54	PS55-135C108
		192"	54	PS55-135C192
	SLATE GRAY	96"	54	PS55-135G96
		108"	54	PS55-135G108
		192"	18	PS55-135G192-P

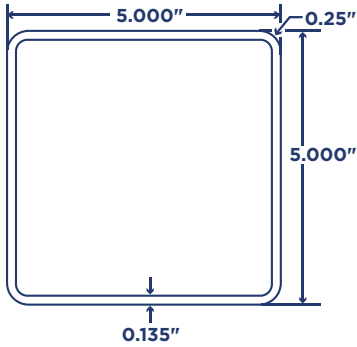

COLORS CONTINUED...

AVAILABLE LENGTH & COLORS

	Color	Length	Bundle Quantity	Part #
Timberland Series*	WEATHERED ASPEN	78"	54	PS55-135W78-W
		96"	54	PS55-135W96-W
		108"	54	PS55-135W108-W
		192"	18	PS55-135W192-W
	DRIFTWOOD	78"	54	PS55-135C78-W
		96"	54	PS55-135C96-W
		108"	54	PS55-135C108-W
		192"	18	PS55-135C192-W-P
	COASTAL CEDAR	78"	54	PS55-135CC78
		96"	54	PS55-135CC96
		108"	54	PS55-135CC108
		192"	54	PS55-135CC192
	DARK WALNUT	78"	54	PS55-135DW78
	DARK SEQUOIA	78"	54	PS55-135DS78
	TEXTURED TAN	96"	54	PS55-135T96-E
		108"	54	PS55-135T108-E
	TEXTURED CLAY	96"	54	PS55-135C96-E
		108"	54	PS55-135C108-E
	TEXTURED DRIFTWOOD	96"	54	PS55-135C96-WE
		108"	54	PS55-135C108-WE
TEXTURED DARK SEQUOIA	78"	54	PS55-135DS78-E	

AVAILABLE COLORS:

Timberland Series

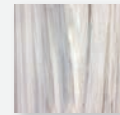

Weathered Aspen

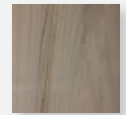

Driftwood

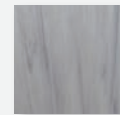

Coastal Cedar

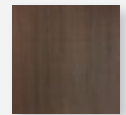

Dark Walnut

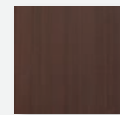

Dark Sequoia

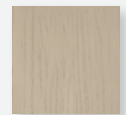

Textured Tan

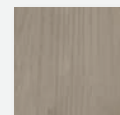

Textured Clay

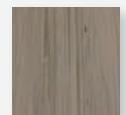

Textured Driftwood

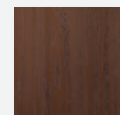

Textured Dark Sequoia

*Timberland Series colors are also sold in pony packs and by the piece. 5"x5" posts: 18 per pony pack.

Posts

Posts

5" X 5" X .135" WALL POSTS 3 RAIL ROUTED POST

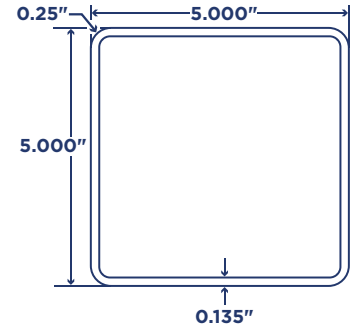
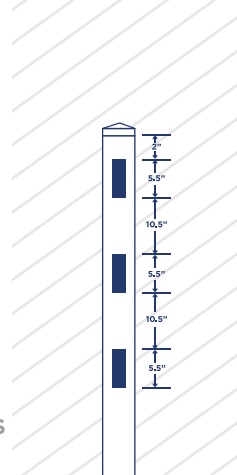

AVAILABLE LENGTH & COLORS

AVAILABLE COLORS:

Standard Color

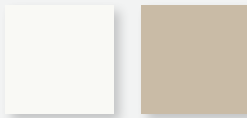

White

Tan



Clay

Slate Gray

Timberland Series



Weathered Aspen

Driftwood

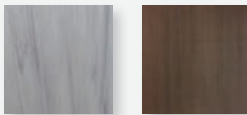

Coastal Cedar

Dark Walnut



Dark Sequoia

Textured Tan



Textured Clay

Textured Driftwood

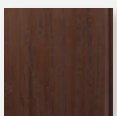

Textured Dark Sequoia

*Timberland Series colors are also sold in pony packs and by the piece. 5"x5" posts: 18 per pony pack.

	Color	Length	Bundle Quantity	Profile	Part #
Standard Color	WHITE	78"	54	Line	PS55-135W78-R3-L
		78"	54	Corner	PS55-135W78-R3-C
		78"	54	End	PS55-135W78-R3-E
	TAN	78"	54	Line	PS55-135T78-R3-L
		78"	54	Corner	PS55-135T78-R3-C
		78"	54	End	PS55-135T78-R3-E
	CLAY	78"	54	Line	PS55-135C78-R3-L
		78"	54	Corner	PS55-135C78-R3-E
		78"	54	End	PS55-135C78-R3-C
	SLATE GRAY	78"	54	Line	PS55-135G78-R3-L
		78"	54	Corner	PS55-135G78-R3-E
		78"	54	End	PS55-135G78-R3-C
Timberland Series*	WEATHERED ASPEN	78"	54	Line	PS55-135W78-W-R3-L
		78"	54	Corner	PS55-135W78-W-R3-C
		78"	54	End	PS55-135W78-W-R3-E
	DRIFTWOOD	78"	54	Line	PS55-135C78-W-R3-L
		78"	54	Corner	PS55-135C78-W-R3-C
		78"	54	End	PS55-135C78-W-R3-E
	COASTAL CEDAR	78"	54	Line	PS55-135CC78-R3-L
		78"	54	Corner	PS55-135CC78-R3-C
		78"	54	End	PS55-135CC78-R3-E
	DARK WALNUT	78"	54	Line	PS55-135DW78-R3-L
		78"	54	Corner	PS55-135DW78-R3-C
		78"	54	End	PS55-135DW78-R3-E
	DARK SEQUOIA	78"	54	Line	PS55-135DS78-E-R3-L
		78"	54	Corner	PS55-135DS78-E-R3-C
		78"	54	End	PS55-135DS78-E-R3-E
	TEXTURED TAN	78"	54	Line	PS55-135T78-E-R3-L
		78"	54	Corner	PS55-135T78-E-R3-C
		78"	54	End	PS55-135T78-E-R3-E
	TEXTURED CLAY	78"	54	Line	PS55-135C78-E-R3-L
		78"	54	Corner	PS55-135C78-E-R3-C
		78"	54	End	PS55-135C78-E-R3-E
	TEXTURED DRIFTWOOD	78"	54	Line	PS55-135C78-WE-R3-L
		78"	54	Corner	PS55-135C78-WE-R3-C
		78"	54	End	PS55-135C78-WE-R3-E
	TEXTURED DARK SEQUOIA	78"	54	Line	PS55-135DS78-E-R3-L
		78"	54	Corner	PS55-135DS78-E-R3-C
		78"	54	End	PS55-135DS78-E-R3-E

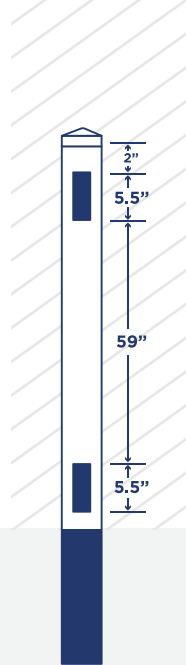
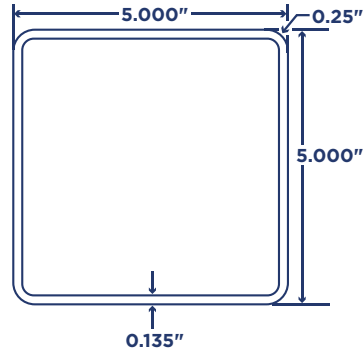

Posts

5" X 5" X .135 WALL PRIVACY POST, ROUTED FOR 1.5" X 5.5" POCKET RAIL, 59" WINDOW

AVAILABLE LENGTH & COLORS

AVAILABLE COLORS:

Standard Color

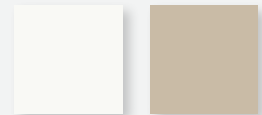

White

Tan



Clay

Slate Gray

Posts

	Color	Length	Bundle Quantity	Profile	Part #
Standard Color	WHITE	96"	54	Line	PS55-135W96-R59-L
		96"	54	Corner	PS55-135W96-R59-C
		96"	54	End	PS55-135W96-R59-E
		108"	54	Line	PS55-135W108-R59-L
		108"	54	Corner	PS55-135W108-R59-C
		108"	54	End	PS55-135W108-R59-E
	TAN	96"	54	Line	PS55-135T96-R59-L
		96"	54	Corner	PS55-135T96-R59-C
		96"	54	End	PS55-135T96-R59-E
		108"	54	Line	PS55-135T108-R59-L
		108"	54	Corner	PS55-135T108-R59-C
		108"	54	End	PS55-135T108-R59-E
	CLAY	96"	54	Line	PS55-135C96-R59-L
		96"	54	Corner	PS55-135C96-R59-C
		96"	54	End	PS55-135C96-R59-E
		108"	54	Line	PS55-135C108-R59-L
		108"	54	Corner	PS55-135C108-R59-C
		108"	54	End	PS55-135C108-R59-E
	SLATE GRAY	96"	54	Line	PS55-135G96-R59-L
		96"	54	Corner	PS55-135G96-R59-C
		96"	54	End	PS55-135G96-R59-E
		108"	54	Line	PS55-135G108-R59-L
		108"	54	Corner	PS55-135G108-R59-C
		108"	54	End	PS55-135G108-R59-E

Posts

5" X 5" X .135 WALL PRIVACY POST, ROUTED FOR 1.5" X 5.5" POCKET RAIL, 59" WINDOW

AVAILABLE COLORS:

Timberland Series



Weathered Aspen

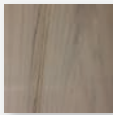

Driftwood

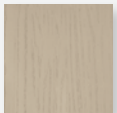

Textured Tan

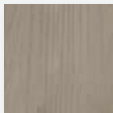

Textured Clay

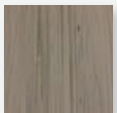

Textured Driftwood

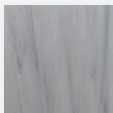

Coastal Cedar

Timberland Series

Color	Length	Bundle Quantity	Profile	Part #
WEATHERED ASPEN	96"	54	Line	PS55-135W96-W-R59-L
	96"	54	Corner	PS55-135W96-W-R59-C
	96"	54	End	PS55-135W96-W-R59-E
	108"	54	Line	PS55-135W108-W-R59-L
	108"	54	Corner	PS55-135W108-W-R59-C
	108"	54	End	PS55-135W108-W-R59-E
DRIFTWOOD	96"	54	Line	PS55-135C96-W-R59-L
	96"	54	Corner	PS55-135C96-W-R59-C
	96"	54	End	PS55-135C96-W-R59-E
	108"	54	Line	PS55-135C108-W-R59-L
	108"	54	Corner	PS55-135C108-W-R59-C
	108"	54	End	PS55-135C108-W-R59-E
TEXTURED TAN	96"	54	Line	PS55-135T96-E-R59-L
	96"	54	Corner	PS55-135T96-E-R59-C
	96"	54	End	PS55-135T96-E-R59-E
	108"	54	Line	PS55-135T108-E-R59-L
	108"	54	Corner	PS55-135T108-E-R59-C
	108"	54	End	PS55-135T108-E-R59-E
TEXTURED CLAY	96"	54	Line	PS55-135C96-E-R59-L
	96"	54	Corner	PS55-135C96-E-R59-C
	96"	54	End	PS55-135C96-E-R59-E
	108"	54	Line	PS55-135C108-E-R59-L
	108"	54	Corner	PS55-135C108-E-R59-C
	108"	54	End	PS55-135C108-E-R59-E
TEXTURED DRIFTWOOD	96"	54	Line	PS55-135C96-WE-R59-L
	96"	54	Corner	PS55-135C96-WE-R59-C
	96"	54	End	PS55-135C96-WE-R59-E
	108"	54	Line	PS55-135C108-WE-R59-L
	108"	54	Corner	PS55-135C108-WE-R59-C
	108"	54	End	PS55-135C108-WE-R59-E
COASTAL CEDAR	96"	54	Line	PS55-135CC96-R59-L
	96"	54	Corner	PS55-135CC96-R59-E
	96"	54	End	PS55-135CC96-R59-C
	108"	54	Line	PS55-135CC108-R59-L
	108"	54	Corner	PS55-135CC108-R59-E
	108"	54	End	PS55-135CC108-R59-C

Posts

5" X 5" X .150" WALL POSTS

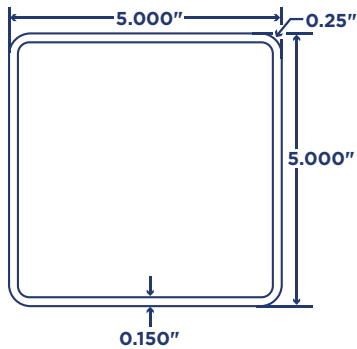

ACCESSORIES

Our 5" x 5" posts have a variety of caps to choose from. See pages 77-80 in the Accessories Section for insert details.

AVAILABLE LENGTH & COLORS

	Color	Length	Bundle Quantity	Part #
Standard Color	WHITE	78"	54	PS55-150W78
		84"	54	PS55-150W84
		96"	54	PS55-150W96
		108"	54	PS55-150W108
		192"	54	PS55-150W192
	TAN	78"	54	PS55-150T78
		96"	54	PS55-150T96
		108"	54	PS55-150T108
		192"	54	PS55-150T192
	CLAY	96"	54	PS55-150C96
		108"	54	PS55-150C108
		192"	54	PS55-150C192
	SLATE GRAY	96"	54	PS55-150G96
		108"	54	PS55-150G108
	Timberland Series*	DARK WALNUT	96"	54
108"			54	PS55-150DW108
192"			18	PS55-150DW192-P
DARK SEQUOIA		96"	54	PS55-150DS96
		108"	54	PS55-150DS108
		192"	18	PS55-150DS192-P
TEXTURED DARK SEQUOIA		96"	54	PS55-150DS96-E
		108"	54	PS55-150DS108-E

AVAILABLE COLORS:

Standard Color

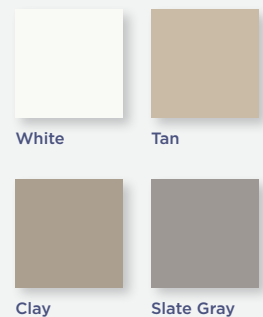

Timberland Series

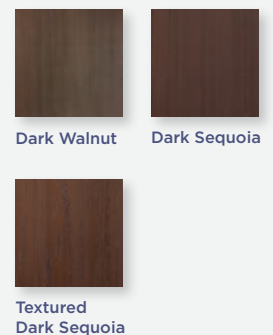

Posts

*Timberland Series colors are also sold in pony packs and by the piece. 5"x5" posts: 18 per pony pack

Posts

5" X 5" X .150" WALL POSTS ROUTED FOR 1.5" X 5.5"

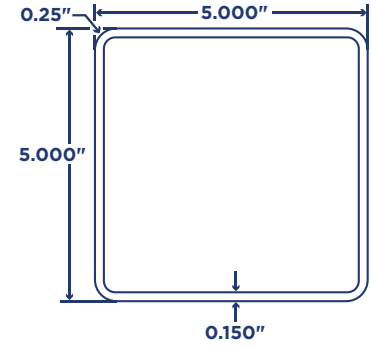
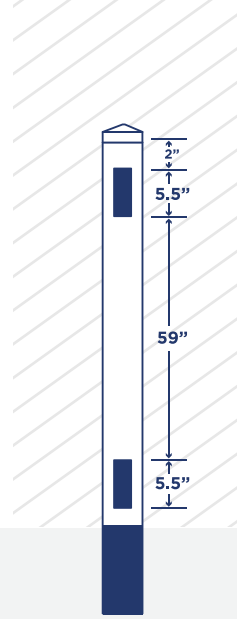

AVAILABLE COLORS:

Timberland Series

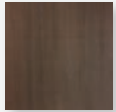

Dark Walnut



Dark Sequoia

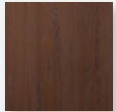

Textured
Dark Sequoia

AVAILABLE LENGTH & COLORS

	Color	Length	Bundle Quantity	Profile	Part #
Timberland Series	DARK WALNUT	96"	54	Line	PS55-150DW96-R59-L
		96"	54	Corner	PS55-150DW96-R59-C
		96"	54	End	PS55-150DW96-R59-E
		108"	54	Line	PS55-150DW108-R59-L
		108"	54	Corner	PS55-150DW108-R59-C
		108"	54	End	PS55-150DW108-R59-E
	DARK SEQUOIA	96"	54	Line	PS55-150DS96-R59-L
		96"	54	Corner	PS55-150DS96-R59-C
		96"	54	End	PS55-150DS96-R59-E
		108"	54	Line	PS55-150DS108-R59-L
		108"	54	Corner	PS55-150DS108-R59-C
		108"	54	End	PS55-150DS108-R59-E
	TEXTURED DARK SEQUOIA	96"	54	Line	PS55-150DS96-E-R59-L
		96"	54	Corner	PS55-150DS96-E-R59-C
		96"	54	End	PS55-150DS96-E-R59-E
		108"	54	Line	PS55-150DS108-E-R59-L
		108"	54	Corner	PS55-150DS108-E-R59-C
		108"	54	End	PS55-150DS108-E-R59-E

Posts

5" X 5" X .250" WALL POSTS

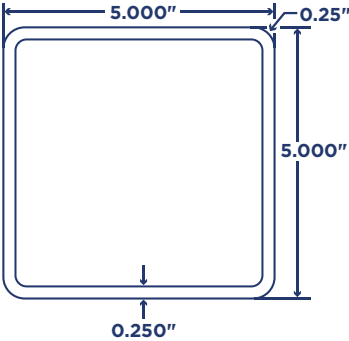

AVAILABLE LENGTH & COLORS

	Color	Length	Bundle Quantity	Part #
Standard Color	WHITE	96"	27	PS55-250W96
		108"	27	PS55-250W108
		144"	27	PS55-250W144
		288"	27	PS55-250W288
	TAN	96"	27	PS55-250T96
		108"	27	PS55-250T108
		288"	27	PS55-250T288

AVAILABLE COLORS:

Standard Color

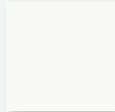

White



Tan

Posts

3 RAIL
in White



Rails

pgs. 33-49



PRIVACY
in Dark Walnut

Rails

1.75" X 3.5" X 0.100" HOLLOW RAIL

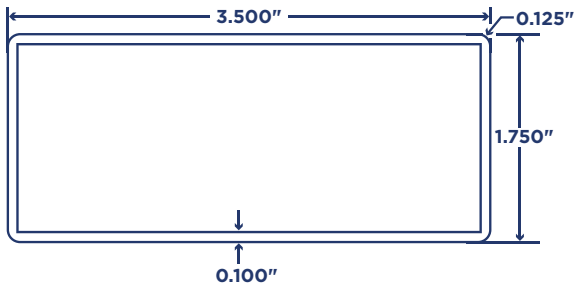

AVAILABLE LENGTH & COLORS

	Color	Length	Bundle Quantity	Part #
Standard Color	WHITE	192"	132	RL17535W192
		144"	24	RL17535W144
	TAN	192"	132	RL17535T192
		144"	24	RL17535T144
	CLAY	192"	24	RL17535C192
	SLATE GRAY	192"	24	RL17535G192

AVAILABLE COLORS:

Standard Color

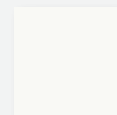

White

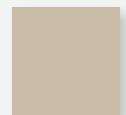

Tan



Clay



Slate Gray

Rails

2" X 3.5" X 0.090" HOLLOW RAIL

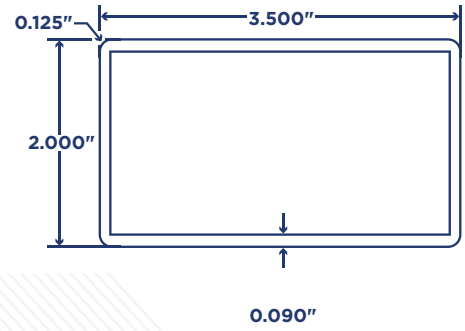

ACCESSORIES



Rail stiffeners are available for this profile. See pages 77-80 in the Accessories Section for stiffener details.

AVAILABLE COLORS:

Standard Color

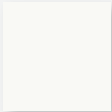

White

AVAILABLE LENGTH & COLORS

	Color	Length	Bundle Quantity	Part #
Standard Color	WHITE	72"	126	RL235-090W72
		96"	126	RL235-090W96
		120"	126	RL235-090W120
		192"	126	RL235-090W192

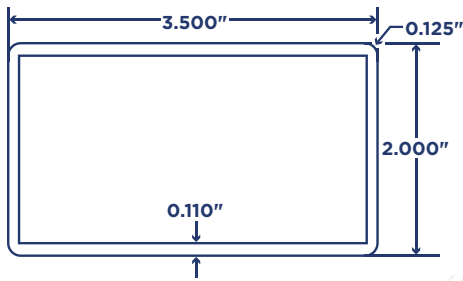

Rails

2" X 3.5" X 0.110" HOLLOW RAIL

ACCESSORIES



Rail stiffeners are available for this profile. See pages 77-80 in the Accessories Section for stiffener details.

AVAILABLE LENGTH & COLORS

	Color	Length	Bundle Quantity	Part #
Standard Color	WHITE	72"	126	RL235W72
		144"	126	RL235W144
		192"	126	RL235W192
	TAN	72"	126	RL235T72
		144"	126	RL235T144
		192"	126	RL235T192
	CLAY	144"	126	RL235C144
		192"	126	RL235C192
	SLATE GRAY	144"	21	RL235G144
	Timberland Series	WEATHERED ASPEN	144"	21
DRIFTWOOD		144"	21	RL235C144-W
COASTAL CEDAR		144"	21	RL235CC144
DARK WALNUT		144"	21	RL235DW144
DARK SEQUOIA		75"	21	RL235DS75
		144"	21	RL235DS144
TEXTURED TAN		75"	21	RL235T75-E
TEXTURED CLAY		75"	21	RL235C75-E
TEXTURED DRIFTWOOD		75"	21	RL235C75-WE
TEXTURED DARK SEQUOIA		75"	21	RL235DS75-E

AVAILABLE COLORS:

Standard Color

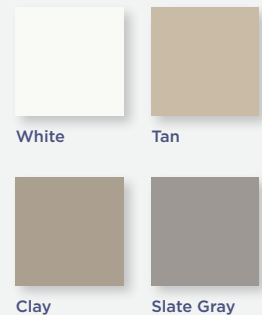

Timberland Series

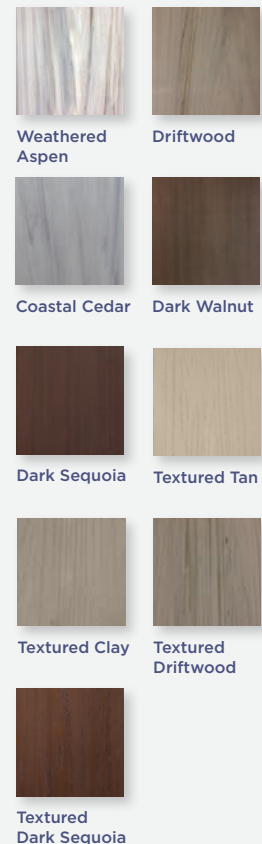

Rails

2" X 3.5" X 0.110" RIBBED RAIL

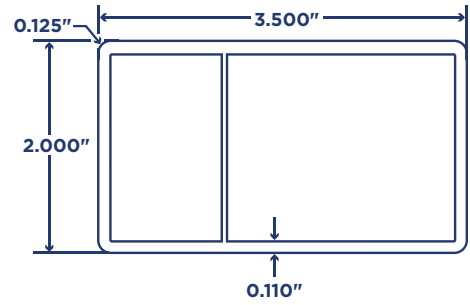

AVAILABLE COLORS:

Standard Color

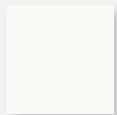

White



Tan

AVAILABLE LENGTH & COLORS

	Color	Length	Bundle Quantity	Part #
Standard Color	WHITE	145"	126	RL235-RIBW145
		193"	126	RL235-RIBW193
	TAN	145"	126	RL235-RIBT145
		193"	126	RL235-RIBT193

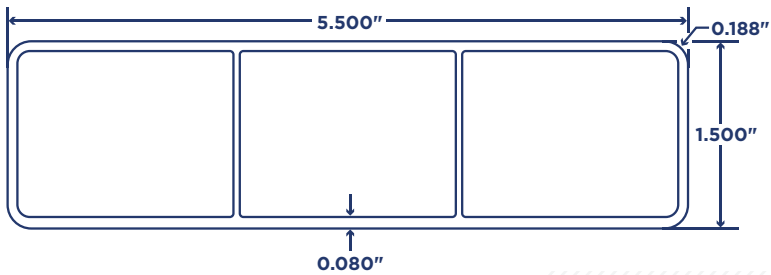

Rails

1.5" X 5.5" X 0.080" RANCH RAIL

ACCESSORIES



Rail stiffeners are available for this profile. See pages 77-80 in the Accessories Section for stiffener details.

AVAILABLE LENGTH & COLORS

	Color	Length	Bundle Qty	Profile	Part #	
Standard Color	WHITE	192"	120	Notched	RL1555-080W192-N	
		192"	120	Non Notched	RL1555-080W192	
	TAN	192"	120	Notched	RL1555-080T192-N	
		192"	120	Non Notched	RL1555-080T192	
	CLAY	192"	120	Notched	RL1555-080C192-N	
		192"	120	Non Notched	RL1555-080C192	
	SLATE GRAY	192"	120	Notched	RL1555-080G192-N	
		192"	120	Non Notched	RL1555-080G192	
	Timberland Series	WEATHERED ASPEN	192"	120	Notched	RL1555-080W192-W-N
			95"	120	Non Notched	RL1555-080W144-W-N
DRIFTWOOD		192"	120	Notched	RL1555-080C192-W-N	
		95"	120	Non Notched	RL1555-080C95-W-N	
COASTAL CEDAR		192"	120	Notched	RL1555-080CC192-N	
		95"	120	Non Notched	RL1555-080CC95-N	
TEXTURED TAN		95"	120	Non Notched	RL1555-080T95-E	
TEXTURED CLAY		95"	120	Non Notched	RL1555-080C95-E	
TEXTURED DRIFTWOOD		95"	120	Non Notched	RL1555-080C95-WE	

AVAILABLE COLORS:

Standard Color

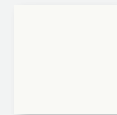

White



Tan



Clay

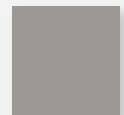

Slate Gray

Timberland Series

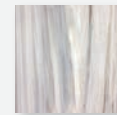

Weathered Aspen

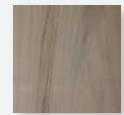

Driftwood

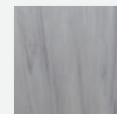

Coastal Cedar

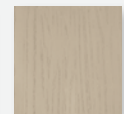

Textured Tan

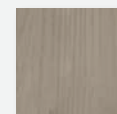

Textured Clay

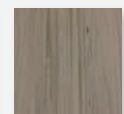

Textured Driftwood

Rails

1.5" X 5.5" X 0.100" RANCH RAIL

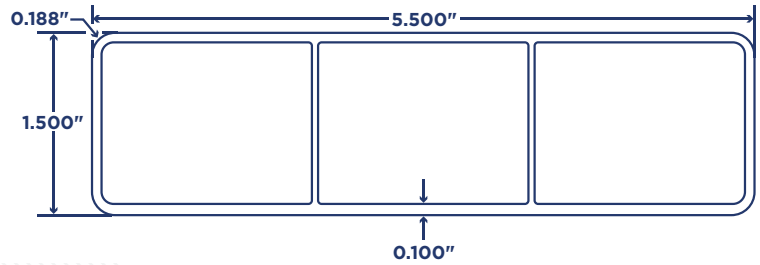

ACCESSORIES



Rail stiffeners are available for this profile. See pages 77-80 in the Accessories Section for stiffener details.

AVAILABLE COLORS:

Standard Color

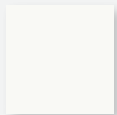

White



Tan

Timberland Series

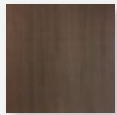

Dark Walnut

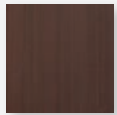

Dark Sequoia

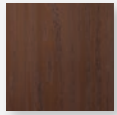

Textured
Dark Sequoia

AVAILABLE LENGTH & COLORS

	Color	Length	Bundle Qty	Profile	Part #
Standard Color	WHITE	144"	120	Non Notched	RL1555-100W144
		192"	120	Non Notched	RL1555-100W192
		192"	120	Notched	RL1555-100W192-N
	TAN	144"	120	Non Notched	RL1555-100T144
		192"	120	Non Notched	RL1555-100T192
Timberland Series	DARK WALNUT	95"	120	Notched	RL1555-100DW95-N
		192"	120	Notched	RL1555-100DW192-N
	DARK SEQUOIA	95"	120	Notched	RL1555-100DS95-N
		192"	120	Notched	RL1555-100DS192-N
	TEXTURED DARK SEQUOIA	95"	120	Notched	RL1555-100DS95-E-N
		95"	120	Non Notched	RL1555-100T95-E

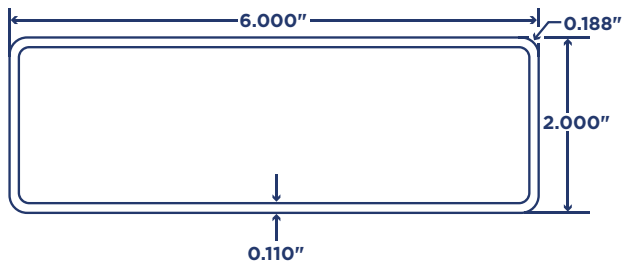

Rails

2" X 6" X 0.110" HOLLOW RAIL

AVAILABLE LENGTH & COLORS

AVAILABLE COLORS:

Standard Color

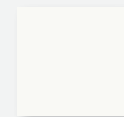

White



Tan

	Color	Length	Bundle Quantity	Part #
Standard Color	WHITE	144"	88	RL26-110W144
		192"	88	RL26-110W192
	TAN	144"	88	RL26-110T144
		192"	88	RL26-110T192

Rails

2" X 6" X 0.100" RIBBED RAIL

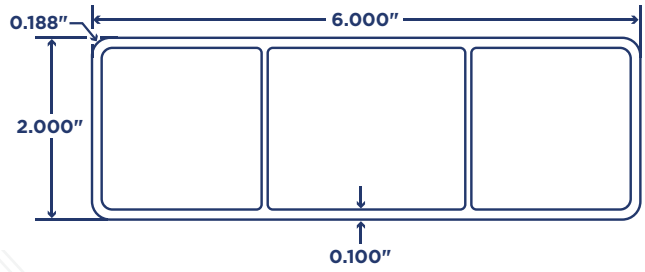

ACCESSORIES



Rail stiffeners are available for this profile. See pages 77-80 in the Accessories Section for stiffener details.

AVAILABLE COLORS:

Standard Color

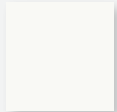

White



Tan

AVAILABLE LENGTH & COLORS

	Color	Length	Bundle Quantity	Part #
Standard Color	WHITE	192"	88	RL26-100W192
	TAN	192"	88	RL26-100T192

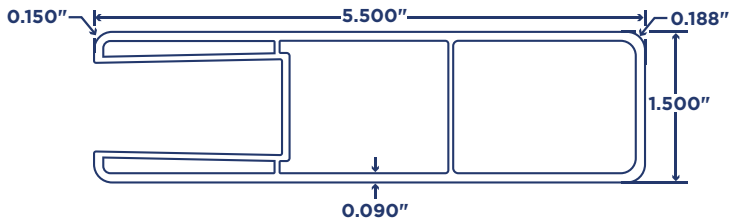

Rails

1.5" X 5.5" X 0.090" POCKET RAIL

ACCESSORIES



Rail stiffeners are available for this profile. See pages 77-80 in the Accessories Section for stiffener details.

AVAILABLE LENGTH & COLORS

*pre-notched rails available upon request

	Color	Length	Bundle Quantity	Part #
Standard Color	WHITE	71.5"	120	DR1555W71
		83"	120	DR1555W83
		95"	120	DR1555W95
		192"	120	DR1555W192
	TAN	71.5"	120	DR1555T71
		83"	120	DR1555T83
		95"	120	DR1555T95
		192"	120	DR1555T192
	CLAY	71.5"	120	DR1555C71
		83"	120	DR1555C83
		95"	120	DR1555C95
	SLATE GRAY	71.5"	120	DR1555G71
		95"	120	DR1555G95

AVAILABLE COLORS:

Standard Color

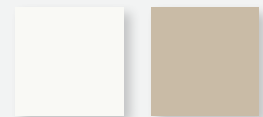

White

Tan



Clay

Slate Gray

Rails

1.5" X 5.5" X 0.090" POCKET RAIL

COLORS CONTINUED...

AVAILABLE COLORS:

Timberland Series

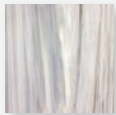

Weathered Aspen

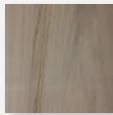

Driftwood

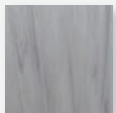

Coastal Cedar

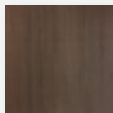

Dark Walnut



Dark Sequoia

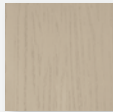

Textured Tan

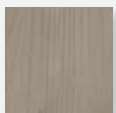

Textured Clay

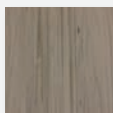

Textured Driftwood

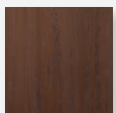

Textured Dark Sequoia

AVAILABLE LENGTH & COLORS

	Color	Length	Bundle Quantity	Part #
Timberland Series* <i>*Timberland Series colors are also sold in pony packs and by the piece. 1.5" x 5.5" Pocket Rails: 30 per pack</i>	WEATHERED ASPEN	71.5"	120	DR1555W71-W
		83"	120	DR1555W83-W
		95"	120	DR1555W95-W
	DRIFTWOOD	71.5"	120	DR1555C71-W
		83"	120	DR1555C83-W
		95"	120	DR1555C95-W
	COASTAL CEDAR	71.5"	120	DR1555CC71
		95"	120	DR1555CC95
	DARK WALNUT	71.5"	120	DR1555DW71
		95"	120	DR1555DW95
	DARK SEQUOIA	71.5"	120	DR1555DS71
		95"	120	DR1555DS95
	TEXTURED TAN	71.5"	120	DR1555T71-E
		83"	120	DR1555T83-E
		95"	120	DR1555T95-E
	TEXTURED CLAY	71.5"	120	DR1555C71-E
		83"	120	DR1555C83-E
		95"	120	DR1555C95-E
	TEXTURED DRIFTWOOD	71.5"	120	DR1555C71-WE
		83"	120	DR1555C83-WE
		95"	120	DR1555C95-WE
	TEXTURED DARK SEQUOIA	71.5"	120	DR1555DS71-E
		95"	120	DR1555DS95-E

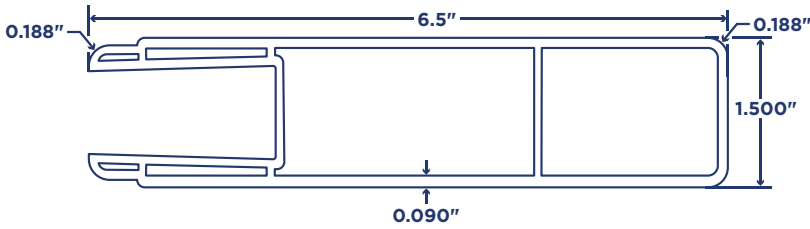

Rails

1.5" X 6.5" X 0.090" POCKET RAIL

ACCESSORIES



Rail stiffeners are available for this profile. See pages 77-80 in the Accessories Section for stiffener details.

AVAILABLE LENGTH & COLORS

	Color	Length	Bundle Quantity	Part #
Standard Color	WHITE	95"	120	DRD1565W95
		192"	120	DRD1565W192
	TAN	95"	120	DRD1565T95
		192"	120	DRD1565T192

AVAILABLE COLORS:

Standard Color

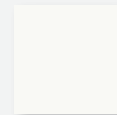

White



Tan

Rails

1.75" X 5.5" X 0.075" POCKET RAIL

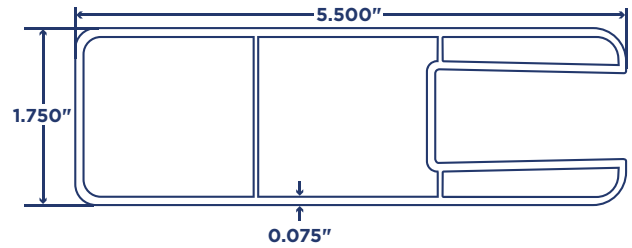

ACCESSORIES



Rail stiffeners are available for this profile. See pages 77-80 in the Accessories Section for stiffener details.

AVAILABLE COLORS:

Standard Color

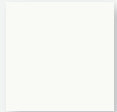

White

AVAILABLE LENGTH & COLORS

	Color	Length	Bundle Quantity	Part #
Standard Color	WHITE	70"	104	DR17555W70-N
		94"	104	DR17555W94-N
		192"	104	DR17555W192

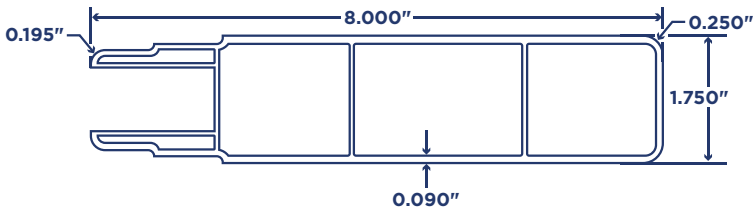

Rails

1.75" X 8" X 0.090" DECO POCKET RAIL

ACCESSORIES



All rails come with steel inserts and towers.
See pages 79 and 80 in the Accessories Section with steel insert details.

AVAILABLE LENGTH & COLORS

AVAILABLE COLORS:

Standard Color

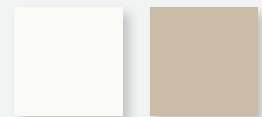

White

Tan



Clay

	Color	Length	Bundle Quantity	Part #
Standard Color	WHITE	71.5"	78	DRD1758W71
		83"	78	DRD1758W83
		95"	78	DRD1758W95
		192"	78	DRD1758W192
	TAN	71.5"	78	DRD1758T71
		83"	78	DRD1758T83
		95"	78	DRD1758T95
		192"	78	DRD1758T192
	CLAY	71.5"	78	DRD1758C71
		83"	78	DRD1758C83
		95"	78	DRD1758C95
		192"	78	DRD1758C192

Rails

2" X 6" X 0.090" DECO POCKET RAIL

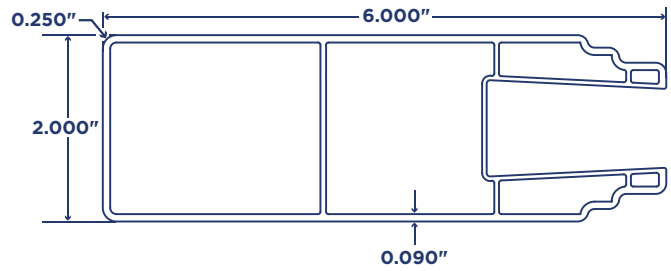

ACCESSORIES



Rail stiffeners are available for this profile. See pages 77-80 in the Accessories Section for stiffener details.

AVAILABLE COLORS:

Standard Color

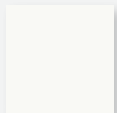

White



Tan

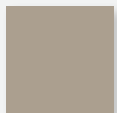

Clay

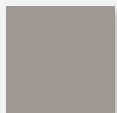

Slate Gray

AVAILABLE LENGTH & COLORS

	Color	Length	Bundle Quantity	Part #
Standard Color	WHITE	71.5"	88	DRD26W71
		95"	88	DRD26W95
		192"	88	DRD26W192
	TAN	71.5"	88	DRD26T71
		95"	88	DRD26T95
		192"	88	DRD26T192
	CLAY	95"	88	DRD26C95
	SLATE GRAY	95"	88	DRD26G95

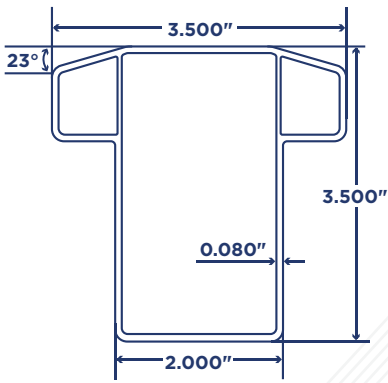

Rails

3.5" X 3.5" X 0.080" T-RAIL

ACCESSORIES



Rail stiffeners are available for this profile. See pages 77-80 in the Accessories Section for stiffener details.



AVAILABLE LENGTH & COLORS

	Color	Length	Bundle Quantity	Part #
Standard Color	WHITE	72"	128	TRL-35W72
		96"	128	TRL-35W96
		192"	128	TRL35W192
	TAN	72"	128	TRL-35T72
		96"	128	TRL-35T96
		192"	128	TRL35T192

AVAILABLE COLORS:

Standard Color

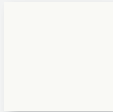

White



Tan

Rails

PRIVACY
in Weathered Aspen



Tongue & Groove

pgs. 51-58

Tongue & Groove

0.875" X 6"

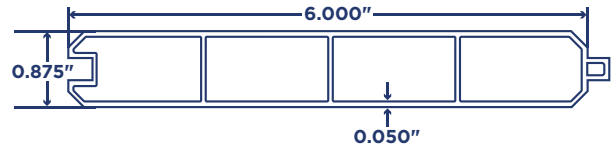

AVAILABLE COLORS:

Standard Color

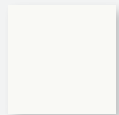

White

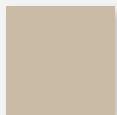

Tan



Clay



Slate Gray

AVAILABLE LENGTH & COLORS

	Color	Length	Bundle Quantity	Part #
Standard Color	WHITE	57.25"	249	TG6W57
		59.75"	249	TG6W59
		62.25"	249	TG6W62
		192"	99	TG6W192
	TAN	57.25"	249	TG6T57
		59.75"	249	TG6T59
		62.25"	249	TG6T62
		192"	99	TG6T192
	CLAY	57.25"	249	TG6C57
		59.75"	249	TG6C59
		62.25"	249	TG6C62
		192"	99	TG6C192
	SLATE GRAY	57.25"	249	TG6G57
		62.25"	249	TG6G62
		192"	99	TG6G192

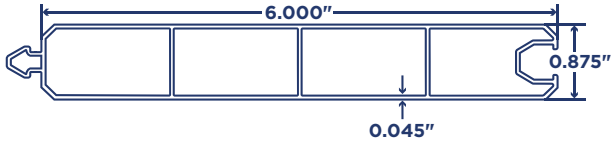

Tongue & Groove 0.875" X 6" (Locking)

AVAILABLE LENGTH & COLORS

	Color	Length	Bundle Quantity	Part #
Standard Color	WHITE	62.25"	249	TGL6W62
		192"	99	TGL6W192
	TAN	62.25"	249	TGL6T62
		192"	99	TGL6T192
	CLAY	62.25"	249	TGL6C62
		192"	99	TGL6C192
	SLATE GRAY	62.25"	249	TGL6G62
		192"	99	TGL6G192

AVAILABLE COLORS:

Standard Color

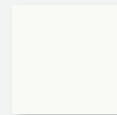

White

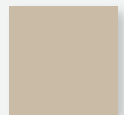

Tan



Clay



Slate Gray

Tongue & Groove

0.875" X 8"

SINGLE GROOVE

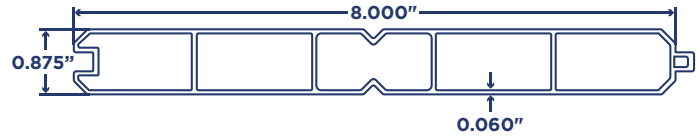

AVAILABLE COLORS:

Standard Color

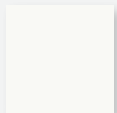

White



Tan

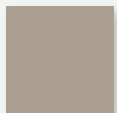

Clay

AVAILABLE LENGTH & COLORS

	Color	Length	Bundle Quantity	Part #
Standard Color	WHITE	59.75"	208	TG8W59.75
		64"	208	TG8W64
		192"	52	TG8W192
	TAN	59.75"	208	TG8T59.75
		64"	208	TG8T64
		192"	52	TG8T192
	CLAY	59.75"	208	TG8C59.75
		192"	208	TG8C192

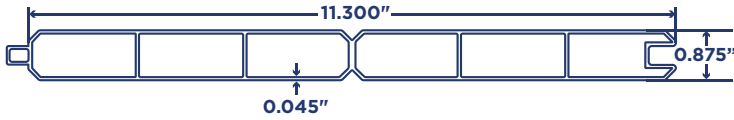

Tongue & Groove

0.875" X 11.3" SINGLE GROOVE

ACCESSORIES



Tongue and Groove stiffeners are available for this profile. See pages 77-80 in the Accessories Section for stiffener details.

AVAILABLE LENGTH & COLORS

	Color	Length	Bundle Quantity	Part #
Standard Color	WHITE	55"	137	TG113-1W55
		60"	137	TG113-1W60
		62.25"	137	TG113-1W62
		192"	52	TG113-1W192
	TAN	55"	137	TG113-1T55
		60"	137	TG113-1T60
		62.25"	137	TG113-1T62
		192"	52	TG113-1T192
	CLAY	55"	137	TG113-1C55
		60"	137	TG113-1C60
		62.25"	137	TG113-1C62

AVAILABLE COLORS:

Standard Color

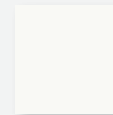

White

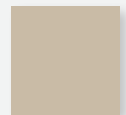

Tan

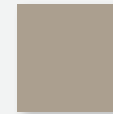

Clay

Tongue & Groove

0.875" X 11.3"
SINGLE GROOVE
COLORS CONTINUED...

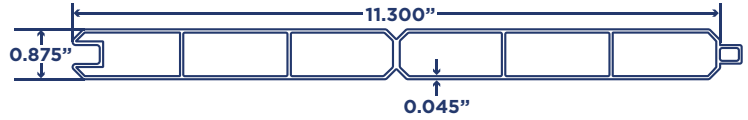

AVAILABLE LENGTH & COLORS

AVAILABLE COLORS:

Timberland Series



Weathered Aspen

Driftwood

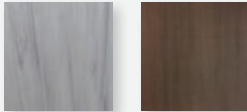

Coastal Cedar

Dark Walnut

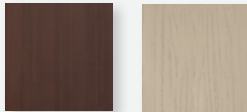

Dark Sequoia

Textured Tan



Textured Clay

Textured Driftwood

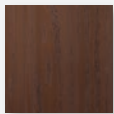

Textured Dark Sequoia

Timberland Series*

*Timberland Series colors are also sold in pony packs and by the piece. 11.3" Single-Groove, T&G Panel: 52 per pony pack

	Color	Length	Bundle Quantity	Part #
Timberland Series*	WEATHERED ASPEN	55"	137	TG113-1W55-W
		60"	137	TG113-1W60-W
		62.25"	137	TG113-1W62-W
		192"	52	TG113-1W192-W
	DRIFTWOOD	55"	137	TG113-1C55-W
		60"	137	TG113-1C60-W
		62.25"	137	TG113-1C62-W
		192"	52	TG113-1C192-W
	COASTAL CEDAR	55"	137	TG113-1CC55
		60"	137	TG113-1CC60
		62.25"	137	TG113-1CC62
		192"	52	TG113-1CC192
	DARK WALNUT	60"	137	TG113-1DW60
		62.25"	137	TG113-1DW62
		192"	52	TG113-1DW192
	DARK SEQUOIA	60"	137	TG113-1DS60
		62.25"	137	TG113-1DS62
	TEXTURED TAN	60"	137	TG113-1T60-E
		62.25"	137	TG113-1T62-E
	TEXTURED CLAY	60"	137	TG113-1C60-E
62.25"		137	TG113-1C62-E	
TEXTURED DRIFTWOOD	60"	137	TG113-1C60-WE	
	62.25"	137	TG113-1C62-WE	
TEXTURED DARK SEQUOIA	60"	137	TG113-1DS60-E	
	62.25"	137	TG113-1DS62-E	

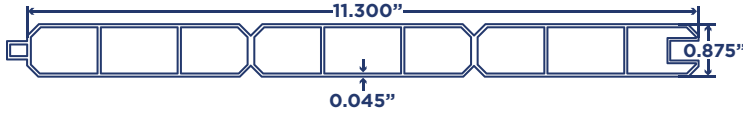

Tongue & Groove

0.875" X 11.3"

DOUBLE GROOVE

AVAILABLE LENGTH & COLORS

AVAILABLE COLORS:

Standard Color

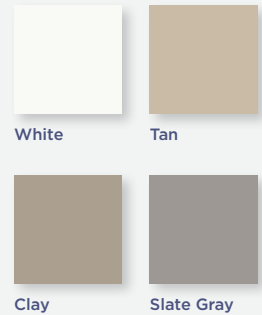

	Color	Length	Bundle Quantity	Part #
Standard Color	WHITE	48"	137	TG113-2W48
		55"	137	TG113-2W55
		57.25"	137	TG113-2W57
		60"	137	TG113-2W60
		62.25"	137	TG113-2W62
		192"	52	TG113-2W192
	TAN	48"	137	TG113-2T48
		55"	137	TG113-2T55
		57.25"	137	TG113-2T57
		60"	137	TG113-2T60
		62.25"	137	TG113-2T62
		192"	52	TG113-2T192
	CLAY	55"	137	TG113-2C55
		57.25"	137	TG113-2C57
		60"	137	TG113-2C60
		62.25"	137	TG113-2C62
		192"	52	TG113-2C192
	SLATE GRAY	55"	137	TG113-2G55
		60"	137	TG113-2G60
		62.25"	137	TG113-2G62
192"		52	TG113-2G192	

Tongue & Groove

0.875" X 11.3"

DOUBLE GROOVE

(Locking)

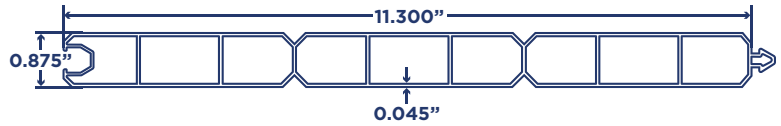

AVAILABLE COLORS:

Standard Color

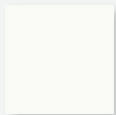

White

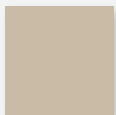

Tan

AVAILABLE LENGTH & COLORS

	Color	Length	Bundle Quantity	Part #
Standard Color	WHITE	60"	137	TGL113-2W60
		62.25"	137	TGL113-2W62
		192"	52	TGL113-2W192
	TAN	60"	137	TGL113-2T60
		62.25"	137	TGL113-2T62
		192"	52	TGL113-2T192

U-Channel

pgs. 59-62

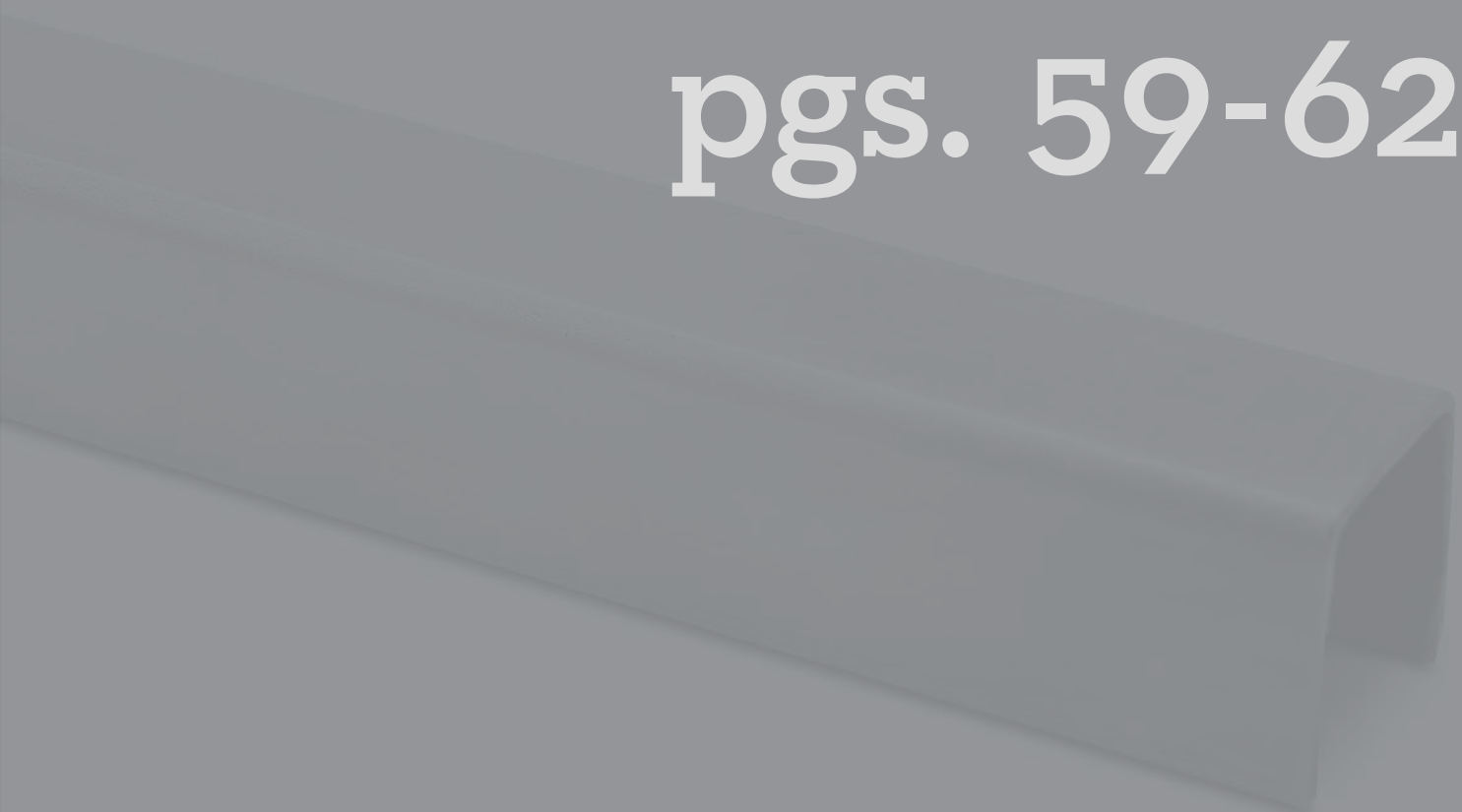

U-Channel

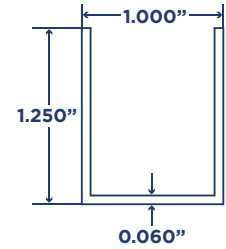

AVAILABLE LENGTH & COLORS

AVAILABLE COLORS:

Standard Color

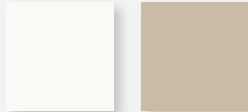

White

Tan



Clay

Slate Gray

Timberland Series



Weathered
Aspen

Driftwood

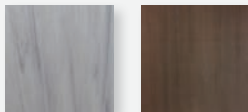

Coastal Cedar

Dark Walnut

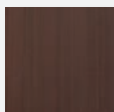

Dark Sequoia

	Color	Length	Bundle Quantity	Part #
Standard Color	WHITE	52"	140*	UCW52
		54"	140*	UCW54
		57"	140*	UCW57
		59"	140*	UCW59
		123"	140*	UCW123
		144"	140*	UCW144
		192"	140*	UCW192
	TAN	52"	140*	UCT52
		54"	140*	UCT54
		57"	140*	UCT57
		59"	140*	UCT59
		123"	140*	UCT123
		144"	140*	UCT144
		192"	140*	UCT192
	CLAY	52"	140*	UCC52
		54"	140*	UCC54
		57"	140*	UCC57
		59"	140*	UCC59
		144"	140*	UCC144
	SLATE GRAY	59"	70*	UCG59
		57"	70*	UCG57
123"		70*	UCG123	
Timberland Series	WEATHERED ASPEN	57"	70*	UCW57-W
		59"	70*	UCW59-W
		123"	70*	UCW123-W
	DRIFTWOOD	57"	70*	UCC57-W
		59"	70*	UCC59-W
		123"	70*	UCC123-W
	COASTAL CEDAR	57"	70*	UCCC57
		59"	70*	UCCC59
		123"	70*	UCCC123
	DARK WALNUT	57"	70*	UCDW57
		59"	70*	UCDW59
		123"	70*	UCDW123
	DARK SEQUOIA	57"	70*	UCDS57
		59"	70*	UCDS59
		123"	70*	UCDS123

*To protect from shipping damage, we recommend that U-Channel is purchased in master bundles of 560 for white, tan and clay or 280 for other colors.

PRIVACY

Weathered Aspen Inlay and Walnut Trim



Fence Section Program

WHAT'S INCLUDED AND HOW DOES IT WORK?

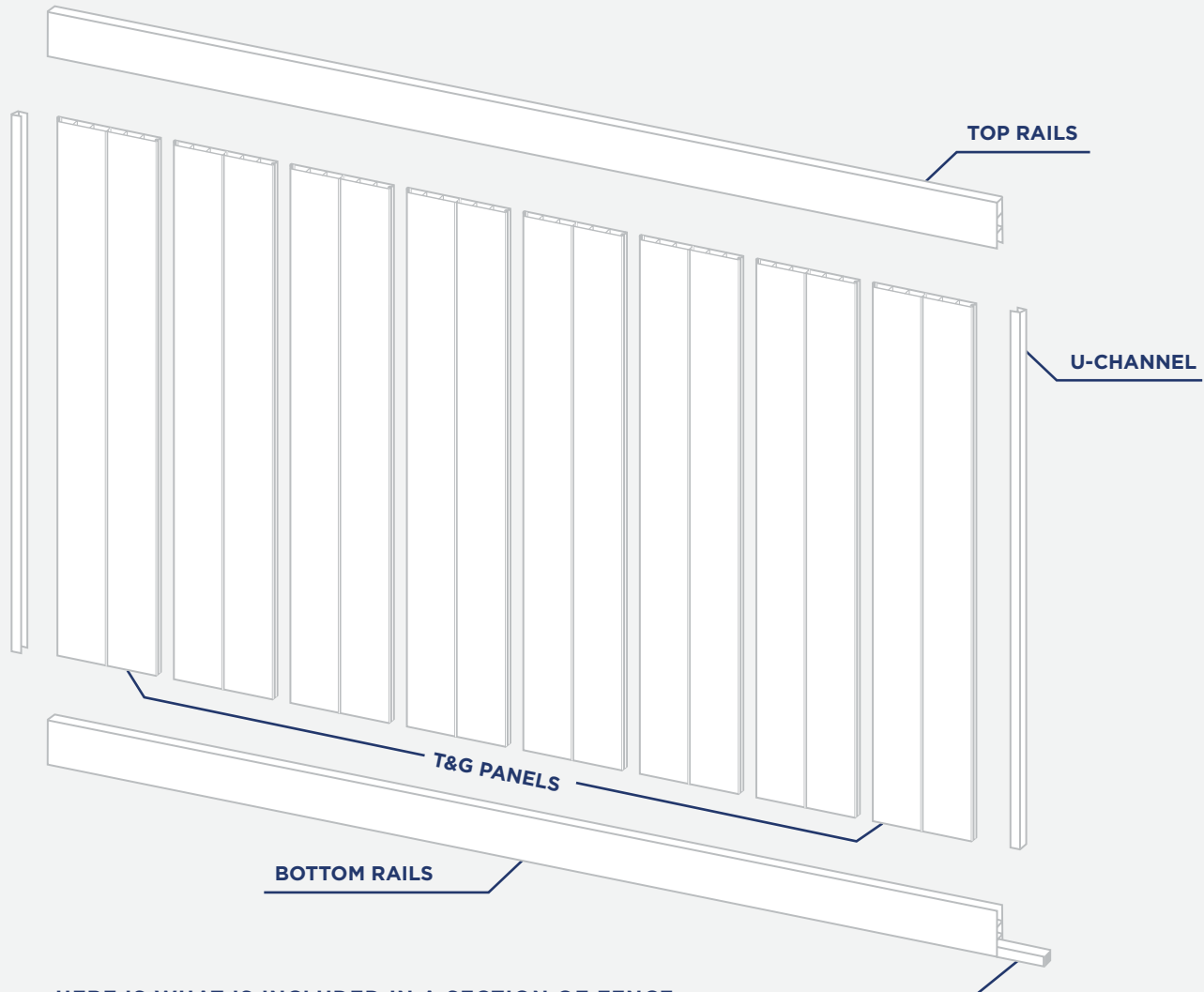

HERE IS WHAT IS INCLUDED IN A SECTION OF FENCE:

- Top and bottom rails
- Tongue and groove panels
- U-channels
- A bottom rail inset – For dark colors a top rail inset is included as well
- Panel insets for dark colors

METAL STIFFENERS

(Number of stiffeners will vary based on color)

STEP 1.

Provide NVP with a list of materials needed for the job. Include what posts are needed (lines, ends, corners, blanks), number sections needed (6ft or 8ft on center), and any gates and extra hardware.

STEP 2.

We take care of the rest. The fence will be delivered with posts, sections, and gates packaged and wrapped individually. Details on what is included with a gate kit is listed on page 86.

FOR MORE INFORMATION CONTACT YOUR LOCAL SALES REPS.

AVAILABLE LENGTH & COLORS

Color		Body Height	Profile Included	Size	Qty	Part #
WEATHERED ASPEN	6'	70"	Pocket Rail	1.5" x 5.5" x 71.5"	2	PRIV001-W-W
			Tongue & Groove - SG	.875" x 11.3" x 62.25"	6	
			U-channel	59"	2	
			Rail Insert	71"	1	
			T&G Insert	60"	0	
DRIFTWOOD	6'	70"	Pocket Rail	1.5" x 5.5" x 71.5"	2	PRIV001-C-W
			Tongue & Groove - SG	.875" x 11.3" x 62.25"	6	
			U-channel	59"	2	
			Rail Insert	71"	1	
			T&G Insert	60"	0	
COASTAL CEDAR	6'	70"	Pocket Rail	1.5" x 5.5" x 71.5"	2	PRIV001-CC
			Tongue & Groove - SG	.875" x 11.3" x 62.25"	6	
			U-channel	59"	2	
			Rail Insert	71"	1	
			T&G Insert	60"	0	
DARK SEQUOIA	6'	70"	Pocket Rail	1.5" x 5.5" x 71.5"	2	PRIV001-DS
			Tongue & Groove - SG	.875" x 11.3" x 62.25"	6	
			U-channel	59"	2	
			Rail Insert	71"	2	
			T&G Insert	60"	2	
DARK WALNUT	6'	70"	Pocket Rail	1.5" x 5.5" x 71.5"	2	PRIV001-DW
			Tongue & Groove - SG	.875" x 11.3" x 62.25"	6	
			U-channel	59"	2	
			Rail Insert	71"	2	
			T&G Insert	60"	2	
TEXTURED TAN	6'	70"	Pocket Rail	1.5" x 5.5" x 71.5"	2	PRIV001-T-E
			Tongue & Groove - SG	.875" x 11.3" x 62.25"	6	
			U-channel	59"	2	
			Rail Insert	71"	1	
			T&G Insert	60"	0	
TEXTURED CLAY	6'	70"	Pocket Rail	1.5" x 5.5" x 71.5"	2	PRIV001-C-E
			Tongue & Groove - SG	.875" x 11.3" x 62.25"	6	
			U-channel	59"	2	
			Rail Insert	71"	1	
			T&G Insert	60"	0	
TEXTURED DRIFTWOOD	6'	70"	Pocket Rail	1.5" x 5.5" x 71.5"	2	PRIV001-C-W-E
			Tongue & Groove - SG	.875" x 11.3" x 62.25"	6	
			U-channel	59"	2	
			Rail Insert	71"	1	
			T&G Insert	60"	0	
TEXTURED DARK SEQUOIA	6'	70"	Pocket Rail	1.5" x 5.5" x 71.5"	2	PRIV001-DS-E
			Tongue & Groove - SG	.875" x 11.3" x 62.25"	6	
			U-channel	59"	2	
			Rail Insert	71"	2	
			T&G Insert	60"	2	

U-Channel



RANCH RAIL
In Weathered Aspen

Accessories

pgs. 65-84

Accessories Index

SECTION OVERVIEW

**AVAILABLE COLORS:
PLEASE SEE EACH
SECTION FOR
INDIVIDUAL COLOR
AVAILABILITY.**

Standard Color



White



Tan



Clay



Slate Gray

Timberland Series

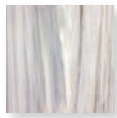

Weathered
Aspen

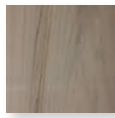

Driftwood

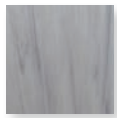

Coastal Cedar

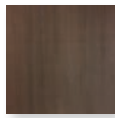

Dark Walnut



Dark Sequoia

This section of the product handbook provides specifications for a variety of vinyl fence accessories available through NVP, including:

- **Caps**
- **Brackets and mounts**
- **Stiffeners**
- **Gate Hardware**
- **Gate kits**
- **Finish Accessories**

NVP offers our standard vinyl accessories in white and tan. Additional colors may be available, but are non-standard products and may need to be ordered from the manufacturer.

NVP has connections with a vast network of fence accessory, post caps and hardware manufacturers. Upon request, NVP can provide pricing and availability for anything not found in this guide. Contact your NVP sales representative, or our inside sales team (orders@nvpfence.com) for more information. NVP ships all accessories in full-box quantities.

**Pricing and availability are subject to change without notice.*

Post Caps: pgs. 68-70

Post Caps

Picket Caps: pgs. 71-73

Picket Caps

Rail End Caps: pgs. 74,75

Rail End Caps

Brackets & Mounts: pgs. 76-78

Brackets & Mounts

Stiffeners: pgs. 79, 80

Stiffeners

Gate Hardware: pgs. 81-83

Gate Hardware

Finishes: pg. 84

Finishes

Accessories

Accessories

POST CAPS

Flat/Pyramid (Long Lipped)

AVAILABLE SIZES AND COLORS

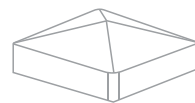

	Color	Size	Box Quantity	Part #
Standard Color	White	4" x 4"	125	CP0026
		5" x 5"	160	CP0030
	Tan	4" x 4"	125	CP0036
		5" x 5"	160	CP0040
	Clay	4" x 4"	125	CP0036C
		5" x 5"	160	CP0040C
Slate Gray	5" x 5"	160	CP0030SG	
Timberland Series	Weathered Aspen	4" x 4"	210	CP0026W-WG
		5" x 5"	160	CP0030W-WG
	Driftwood	4" x 4"	210	CP0026C-WG
		5" x 5"	160	CP0030C-WG
	Dark Walnut	4" x 4"	210	CP0026DW
		5" x 5"	160	CP0030DW
	Dark Sequoia	4" x 4"	210	CP0026DS
		5" x 5"	160	CP0030DS
	Coastal Cedar	4" x 4"	210	CP0026CC
		5" x 5"	160	CP0030CC
	Textured Tan	5" x 5"	56	CP0100T-E
	Textured Clay	5" x 5"	56	CP0100C-E
Textured Driftwood	5" x 5"	56	CP0100C-WG-E	
Textured Dark Sequoia	5" x 5"	56	CP0100DS-E	

Federation

AVAILABLE SIZES AND COLORS



	Color	Size	Box Quantity	Part #
Standard Color	White	4" x 4"	40	CP0025
		5" x 5"	40	CP0029
	Tan	4" x 4"	40	CP0035
		5" x 5"	40	CP0039
	Clay	4" x 4"	40	CP0035C
		5" x 5"	40	CP0039C

Accessories

POST CAPS

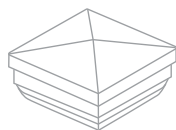

New England

AVAILABLE SIZES AND COLORS

	Color	Size	Box Quantity	Part #
Standard Color	White	4" x 4"	32	CP0025A
		5" x 5"	60	CP0029A
	Tan	4" x 4"	32	CP0025B
		5" x 5"	60	CP0039A
	Clay	4" x 4"	32	CP0025C
		5" x 5"	60	CP0039D
Timberland Series	Weathered Aspen	5" x 5"	60	CP0039W-WG
	Driftwood	5" x 5"	60	CP0039D-WG
	Dark Walnut	5" x 5"	60	CP0039DW-WG
	Dark Sequoia	5" x 5"	60	CP0039DS-WG
	Coastal Cedar	5" x 5"	60	CP0039CC



Gothic

AVAILABLE SIZES AND COLORS

	Color	Size	Box Quantity	Part #
Standard Color	White	4" x 4"	45	CP0027
		5" x 5"	45	CP0031
	Tan	4" x 4"	45	CP0037
		5" x 5"	45	CP0041
	Clay	4" x 4"	45	CP0037C
		5" x 5"	45	CP0041C



Dome Caps

AVAILABLE SIZES AND COLORS

	Color	Size	Box Quantity	Part #
Standard Color	White	4" x 4"	60	CP0028
		5" x 5"	60	CP0038

Accessories

POST CAPS

Galaxy Solar Post Cap

AVAILABLE SIZES AND COLORS

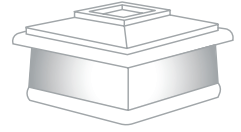

	Color	Size	Box Quantity	Part #
Standard Color	White	4" x 4"	24	CP0095
		5" x 5"		
	Tan	4" x 4"	24	CP0096
		5" x 5"		
	Clay	4" x 4"	24	CP0096C
		5" x 5"		

Cape May Scalloped Lens Solar Light Post Cap

AVAILABLE SIZES AND COLORS

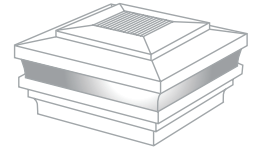

	Color	Size	Box Quantity	Part #
Standard Color	White	4" x 4"	6	CP0097
		5" x 5"	6	CP0097B
	Tan	4" x 4"	6	CP0098
		5" x 5"	6	CP0098B
	Clay	4" x 4"	6	CP0099
		5" x 5"	6	CP0099B

Accessories

PICKET CAPS



Sharp (Non Self-Locking)

AVAILABLE SIZES AND COLORS

	Color	Size	Box Quantity	Part #
Standard Colors	White	0.875" x 1.5"	400	CP0001
		0.875" x 3"	250	CP0003B
	Tan	0.875" x 1.5"	400	CP0009
		0.875" x 3"	250	CP0011B



Sharp (Self-Locking)

AVAILABLE SIZES AND COLORS

	Color	Size	Box Quantity	Part #
Standard Colors	White	0.875" x 3"	250	CP0003
	Tan	0.875" x 3"	250	CP0011

Accessories

PICKET CAPS

Dog Ear (Self Locking)

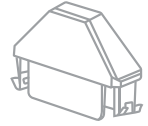

AVAILABLE SIZES AND COLORS

	Color	Size	Box Quantity	Part #
Standard Colors	White	0.875" x 3"	250	CP0002
		.875" x 6"	125	CP0014B
	Tan	0.875" x 3"	250	CP0010
		.875" x 6"	125	CP0017B

Dog Ear (Non Self-Locking)



AVAILABLE SIZES AND COLORS

	Color	Size	Box Quantity	Part #
Standard Colors	White	0.875" x 3"	400	CP0002A
		0.875" x 6"	125	CP0091
	Tan	0.875" x 3"	400	CP0010B
		0.875" x 6"	125	CP0091B
Timberland Series	Weathered Aspen	0.875" x 3"	300	CP0002AW-WG
	Driftwood	0.875" x 3"	300	CP0002AC-WG
	Dark Walnut	0.875" x 3"	300	CP0002ADW
	Dark Sequoia	0.875" x 3"	300	CP0002ADS
	Coastal Cedar	0.875" x 3"	300	CP0002ACC

Pyramid



AVAILABLE SIZES AND COLORS

	Color	Size	Box Quantity	Part #
Standard Color	White	1.375" x 1.375"	500	CP0007
		1.5" x 1.5"	500	CP0020
		1.75" x 1.75"	400	CP0018
	Tan	1.375" x 1.375"	500	CP0015
		1.5" x 1.5"	500	CP0021
		1.75" x 1.75"	400	CP0019

Accessories

PICKET CAPS



Arrowhead

AVAILABLE SIZES AND COLORS

	Color	Size	Box Quantity	Part #
Standard Color	White	1" x 1"	300	CP0004
	Tan	1" x 1"	300	CP0012



Boy Scout

AVAILABLE SIZES AND COLORS

	Color	Size	Box Quantity	Part #
Standard Color	White	1" x 1"	500	CP0005
	Tan	1" x 1"	500	CP0013



Gothic

AVAILABLE SIZES AND COLORS

	Color	Size	Box Quantity	Part #
Standard Color	White	1" x 1"	500	CP0006
		1.5" x 1.5"	350	CP0022
	Tan	1" x 1"	500	CP0014
		1.5" x 1.5"	350	CP0023



Flat

AVAILABLE SIZES AND COLORS

	Color	Size	Box Quantity	Part #
Standard Color	White	1.75" x 1.75"	300	CP0008
	Tan	1.75" x 1.75"	300	CP0016

Accessories

RAIL END CAPS

Flat Rail End Cap (External)



AVAILABLE SIZES AND COLORS

	Color	Size	Box Quantity	Part #
Standard Color	White	1.75" x 3.5"	150	CP0076F
		2" x 3.5"	114	CP0076E
		2" x 6"	100	CP0073
	Tan	1.75" x 3.5"	150	CP0079F
		2" x 3.5"	114	CP0079E
		2" x 6"	100	CP0074
	Clay	2" x 3.5"	150	CP0079D
	Slate Gray	2" x 3.5"	114	CP0076G
	Timberland Series	Weathered Aspen	2" x 3.5"	114
Driftwood		2" x 3.5"	114	CP0079D-WG
Dark Walnut		2" x 3.5"	114	CP0079DW
Dark Sequoia		2" x 3.5"	114	CP0079DS
Coastal Cedar		2" x 3.5"	114	CP0079CC

Flat Rail End Cap



AVAILABLE SIZES AND COLORS

	Color	Size	Box Quantity	Part #
Standard Color	White	1.5" x 5.5"	400	CP0075
		2" x 3.5"	650	CP0076
		2" x 6"	200	CP0077
	Tan	1.5" x 5.5"	400	CP0078
		2" x 3.5"	650	CP0079
		2" x 6"	200	CP0080
	Clay	1.5" x 5.5"	400	CP0078C
		2" x 3.5"	650	CP0079C

Pergola Rail End Cap

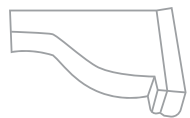

AVAILABLE SIZES AND COLORS

	Color	Size	Box Quantity	Part #
Standard Color	White	1.5" x 5.5"	32	CP0089
		2" x 6"	24	CP0085
	Tan	1.5" x 5.5"	32	CP0090
		2" x 6"	24	CP0086

Accessories

RAIL END CAPS

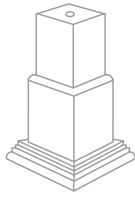

Foot Block

AVAILABLE SIZES AND COLORS

	Color	Size	Box Quantity	Part #
Standard Color	White	2" to 3.5" adjustable height	50	RB0050
	Tan	2" to 3.5" adjustable height	114	RB0051
	Clay	2" to 3.5" adjustable height	100	RB0051C

Rail End Caps

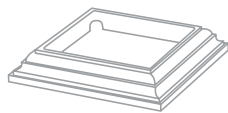

Post Skirts

AVAILABLE SIZES AND COLORS

	Color	Size	Box Quantity	Part #
Standard Color	White	4" x 4"	32	SK0001
	Tan	4" x 4"	32	SK0003
	Clay	4" x 4"	32	SK0003C

Accessories

BRACKETS & MOUNTS

Rail Bracket Kit

AVAILABLE SIZES AND COLORS

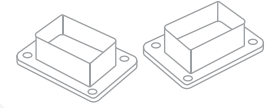

	Color	Size	Box Quantity	Part #
Standard Color	White	2" x 3.5"	30	RB0001
	Tan	2" x 3.5"	30	RB0009
	Clay	2" x 3.5"	60	RB0020

Rail Stair Bracket

AVAILABLE SIZES AND COLORS

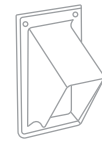

	Color	Size	Box Quantity	Part #
Standard Color	White	T-Rail and 2"x 3.5"	30	RB0042
		2" x 3.5"	30	RB0002
	Tan	T-Rail and 2"x 3.5"	30	RB0043
		2" x 3.5"	60	RB0010
	Clay	T-Rail and 2"x 3.5"	30	RB0043C

T-Rail Bracket

AVAILABLE SIZES AND COLORS

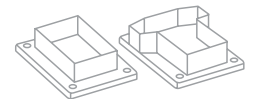

	Color	Size	Box Quantity	Part #
Standard Color	White	T-Rail and 2"x 3.5"	30	RB0040
	Tan	T-Rail and 2"x 3.5"	30	RB0041
	Clay	T-Rail and 2"x 3.5"	30	RB0041C

Accessories

BRACKETS & MOUNTS

Ground Sleeve

AVAILABLE SIZES



Size	Box Quantity	Part #
4" x 4", 24"	48	ST0001
5" x 5", 24"	48	ST0002

Universal Post Mount (Lines, Ends & Corners)

AVAILABLE SIZES



Size	Box Quantity	Part #
4" x 4", 24"	50	ST0014
4" x 4", 48"	50	ST0014C
5" x 5", 24"	50	ST0015
5" x 5", 48"	50	ST0015C



Blu-Mount Heavy Duty for 4" Posts w/PVC Guides

AVAILABLE SIZES



Size	Height	Hardware	Box Quantity	Part #
4" x 4"	36"	Concrete	1	MP0001C
4" x 4"	36"	Wood	1	MP0001W
4" x 4"	42"	Concrete	1	MP0002C
4" x 4"	42"	Wood	1	MP0002W



Wizard Post Mount General Purpose w/4" Top Leveling Guide

AVAILABLE SIZES

Size	Height	Hardware	Box Quantity	Part #
4" x 4"	36" - 42"	Concrete	1	MP0010C
4" x 4"	36" - 42"	Wood	1	MP0010W

Accessories

BRACKETS & MOUNTS

Rail Mount

AVAILABLE SIZES AND COLORS

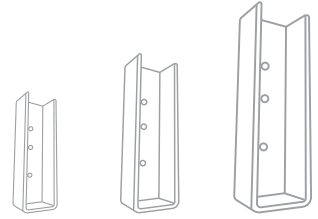

	Color	Size	Box Quantity	Part #
Standard Color	White	1.5" x 5.5"	100	MR0001
		2" x 3.5"	100	MR0002
		2" x 6"	100	MR0003
	Tan	1.5" x 5.5"	100	MR0004
		2" x 3.5"	100	MR0005
		2" x 6"	100	MR0006
	Clay	1.5" x 5.5"	100	MR0007

Adjustable Post Socket

AVAILABLE SIZES AND COLORS

Size	Box Quantity	Part #
1 7/8" pipe for a 5" x 5" post	36	MP0001
2 3/8" pipe for a 5" x 5" post	36	MP0001B
1 7/8" pipe for a 4" x 4" post	36	MP0002
2 3/8" pipe for a 4" x 4" post	36	MP0002B



For installing PVC Posts over chain link pipe

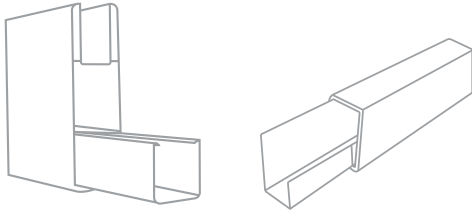

Accessories

RAIL STIFFENERS

Steel Rail Stiffener

AVAILABLE SIZES AND COLORS

Shape	Gauge	Length	Profile Fit	Part #
U	20ga	71"	1.5" x 5.5", 1.5" x 6.5", 1.75" x 5.5", 1.75" x 8"	ST0021
U	20ga	82"	1.5" x 5.5", 1.5" x 6.5", 1.75" x 5.5", 1.75" x 8"	ST0023
U	20ga	94"	1.5" x 5.5", 1.5" x 6.5", 1.75" x 5.5", 1.75" x 8"	ST0022A
U	20ga	96"	1.5" x 5.5", 1.5" x 6.5", 1.75" x 5.5", 1.75" x 8"	ST0022
U	20ga	71"	2" x 6", 2" x 7"	ST0020
U	20ga	94"	2" x 6", 2" x 7"	ST0020B
J	18ga	71"	2" x 3.5", T-Rail	ST0009
J	18ga	94"	2" x 3.5", T-Rail	ST0010

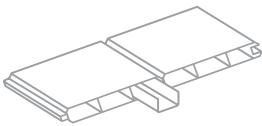

Steel Panel Stiffener

AVAILABLE SIZES AND COLORS

Shape	Gauge	Length	Profile Fit	Part #
U	20ga	60"	All T&G and .875" Pickets	ST0031
U	20ga	62"	All T&G and .875" Pickets	ST0031B
U	20ga	96"	All T&G and .875" Pickets	ST0032



Aluminum "I" Rail Stiffener

AVAILABLE SIZES AND COLORS

Shape	Gauge	Length	Profile Fit	Part #
I	24ga	70"	1.5" x 5.5", 1.5" x 6.5", 1.75" x 5.5", 1.75" x 8"	ST0019
I	24ga	82"	1.5" x 5.5", 1.5" x 6.5", 1.75" x 5.5", 1.75" x 8"	ST0018
I	24ga	96"	1.5" x 5.5", 1.5" x 6.5", 1.75" x 5.5", 1.75" x 8"	ST0017



Aluminum "A" Rail Stiffener

AVAILABLE SIZES AND COLORS

Shape	Gauge	Length	Profile Fit	Part #
A	12ga	70"	2" x 3.5", T-Rail	ST0040
A	12ga	94"	2" x 3.5", T-Rail	ST0041

Accessories

RAIL STIFFENERS

Aluminum 'I' Panel Stiffener – All T&G and .875" Pickets



AVAILABLE SIZES AND COLORS

Shape	Gauge	Profile Fit	Length	Part #
I	24ga	All T&G and .875" Pickets	55"	ST0030
			62"	ST0030A

Accessories

POST STIFFENERS

Steel Post Stiffener

AVAILABLE SIZES AND COLORS

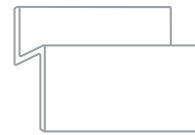

"Z"

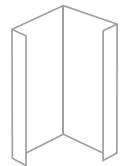

"L"

Shape	Gauge	Length	Profile Fit	Part #
L	14ga	72"	4" x 4"	ST0006
L	14ga	96"	5" x 5" (excludes .250 wall)	ST0007
U	14ga	94"	5" x 5" (excludes .250 wall)	ST0025
Z	14ga	48"	5" x 5" (excludes .250 wall)	ST0008C
Z	14ga	96"	5" x 5" (excludes .250 wall)	ST0008

Aluminum Post Stiffener

AVAILABLE SIZES AND COLORS

Shape	Gauge	Length	Profile Fit	Part #
L	18ga	96"	5" x 5" (excludes .250 wall)	ST0006B
H	18ga	96"	5" x 5" (excludes .250 wall)	ST0006C

Accessories

GATE HARDWARE

Aluminum Tubing (fits over gate corners)

AVAILABLE SIZES & COLORS

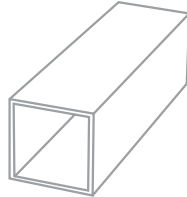

Size	Box Quantity	Part #
1.25" x 1.25", 24'	100	GT0009
1.5" x 1.5", 22'	100	GT0010

90 Degree Gate Corner

AVAILABLE SIZES & COLORS

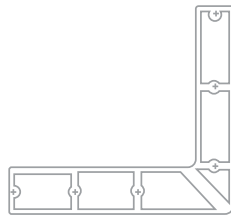

Degree of Angle	Box Quantity	Part #
90	50	GT0001

Angled Gate Corner Set (Includes 4 corners, 2 of each degree. Used for building racked gates)

AVAILABLE SIZES & COLORS

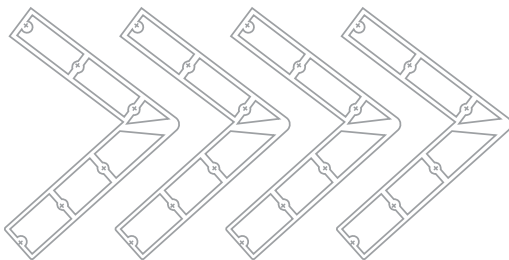

Degree of Angle	Box Quantity	Part #
92+88	1 Set Of 4	GT0002
93+87	1 Set Of 4	GT0003
94+86	1 Set Of 4	GT0004
95+85	1 Set Of 4	GT0005
96+84	1 Set Of 4	GT0006
97+83	1 Set Of 4	GT0007
98+82	1 Set Of 4	GT0008

Accessories

GATE HARDWARE

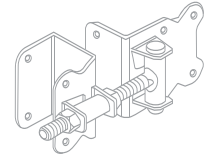

Vinyl To Steel (Complete hinge set with screws. Fits all 3"-6" posts.)

AVAILABLE SIZES & COLORS

Material	Color	Box Quantity	Part #
Zinc Coated 1.75" Frame	White	12	GT0037
	Black	12	GT0041
Zinc Coated 2" Frame	White	12	GT0037B
	Black	12	GT0041B

Vinyl To Steel, Self Closing Hinge (Complete hinge set with screws. Fits all 3"-6" posts.)

AVAILABLE SIZES AND COLORS

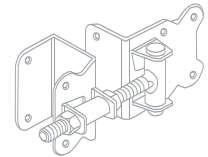

Material	Color	Box Quantity	Part #
Zinc Coated 1.75" Frame	White	12	GT0038
	Black	12	GT0042
Zinc Coated 2" Frame	White	12	GT0038B
	Black	12	GT0042B

Vinyl To Vinyl, Non Self Closing Hinge (Complete hinge set with screws. Fits all 3"-6" posts.)

AVAILABLE SIZES AND COLORS

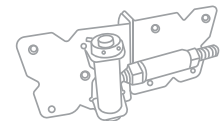

Material	Color	Box Quantity	Part #
Zinc Coated Frame	White	12	GT0035
	Black	12	GT0039

Vinyl To Vinyl, Self Closing Hinge (Complete hinge set with screws. Fits all 3"-6" posts.)

AVAILABLE SIZES AND COLORS

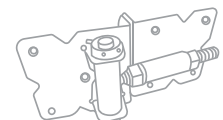

Material	Color	Box Quantity	Part #
Zinc Coated Frame	White	12	GT0036
	Black	12	GT0040

Accessories

GATE HARDWARE

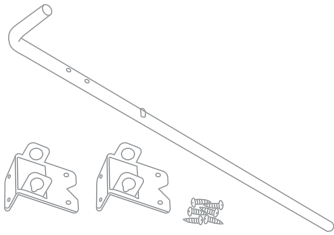

Drop Rod (Mounting brackets & screws included)

AVAILABLE SIZES & COLORS

Material	Color	Box Quantity	Part #
Zinc Coated 36"	White	10	GT0025
	Black	10	GT0026
Zinc Coated 48"	White	10	GT0029
	Black	10	GT0030

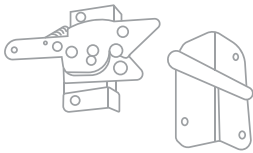

Gate Paddle Latch W/Lock located on both sides. (Complete hinge set with screws. Fits all 3"-6" posts.)

AVAILABLE SIZES & COLORS

Material	Color	Box Quantity	Part #
Zinc Coated Frame	White	20	GT0075
	Black	20	GT0077



Mini Paddle Latch

AVAILABLE SIZES & COLORS

Material	Color	Box Quantity	Part #
Zinc Coated Frame	White	50	GT0076
	Black	50	GT0078

Gate Cable Kit (Complete with brackets & toggle bolt.)

AVAILABLE SIZES

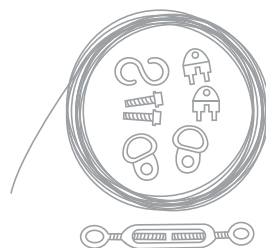

Material	Box Quantity	Part #
8'	60	GT0021

Accessories

FINISHES

PVC Glue

AVAILABLE SIZES AND COLORS



	Color	Size	Box Quantity	Part #
Standard Color	White	1.5 oz	24	GL0003
		8 oz	8	GL0001
	Tan	1.5 oz	24	GL0004
		8 oz	8	GL0002

Hole Plug

AVAILABLE SIZES AND COLORS



	Color	Size	Box Quantity	Part #
Standard Color	White	0.625"	500	HP0001
		1"	500	HP0020
	Tan	0.625"	500	HP0002
		1"	500	HP0021
	Weathered Aspen	0.625"	500	HP0003
	Driftwood	0.625"	500	HP0005
	Dark Walnut	0.625"	500	HP0006
	Dark Sequoia	0.625"	500	HP0007
Coastal Cedar	0.625"	500	HP0008	

Snap Cap & Washer

AVAILABLE SIZES AND COLORS



	Color	Box Quantity	Part #	Washer Part #
Standard Color	White	1000	SC0001	SC0004
	Tan	1000	SC0002	SC0004

PORCH RAIL
in White



Gate-In-A-Box

BUILD INSTRUCTIONS

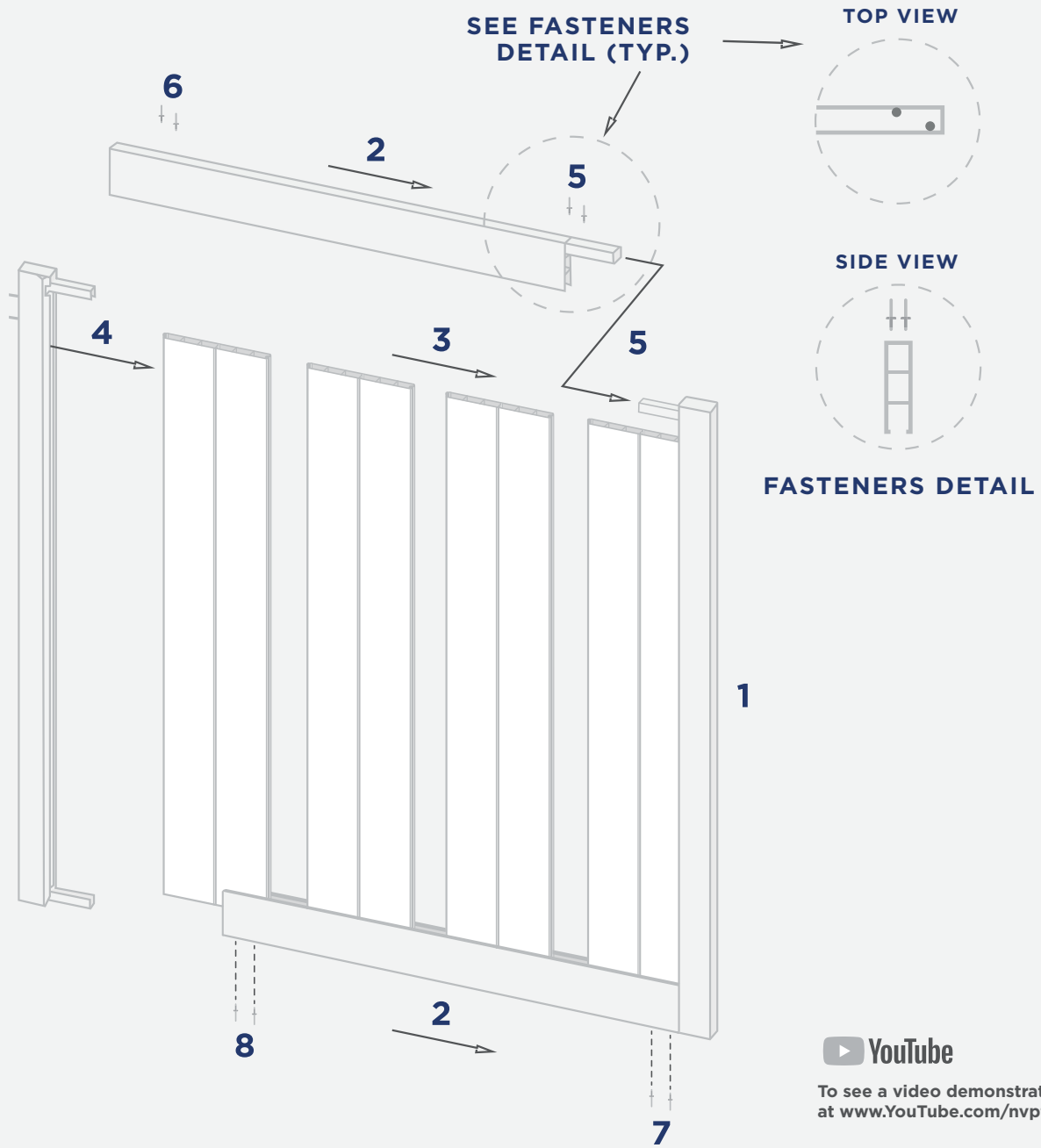

To see a video demonstration, visit us at www.YouTube.com/nvpfence

Gate-In-A-Box

BUILD INSTRUCTIONS

WHAT'S IN THE BOX:

- Tongue and Groove (T&G) Pickets
- Top and Bottom Vinyl Pocket Rails
- Vinyl Uprights – Pre-routed for easy assembly
- Aluminum Tubing
- Self Tapping Screws
- Instruction Sheet
- Aluminum Corners (Standard 90 degrees, other degree slopes are avail.)

(FOLLOW THE STEP NUMBERS ON THE SCHEMATIC DRAWING)

STEP 1

Start with the gate upright: a rectangular vinyl profile with the aluminum tubing inside and the gate corners inserted and pre-attached.

STEP 2

Slide the top and bottom vinyl pocket rails (and the aluminum tubing inside them) over the gate corners from Step 1's gate upright. Make sure the pocket rail slides all the way into the routed opening and tubing slides all the way over the gate corner.

STEP 3

Slide the tongue and groove (T&G) pickets between the two pocket rails, tight to the gate upright.

STEP 4

Take the remaining gate upright and slide it into the top and bottom pocket rails, similar to step 1. Make sure the pocket rails and the T&G pickets fit all the way into the routed opening in the gate upright. The T&G Pickets should slide a small amount into the gate upright slot to create a clean finish.

**Before completing Step 5, it's recommended to utilize clamps or nylon ratchet straps along the width of the gate to make sure the components are tight together and the gate is square.*

STEP 5, 6, 7, AND 8

Utilize the provided self tapping screws to screw the pocket rail, gate corner, and tubing all together. Place the fasteners in a location where they will grab all three components (pocket rail, gate corner, and tubing).

GENERAL NOTES:

Gates are made to be 2" shorter than the rough opening (i.e. a 48" opening from inside gate post to inside gate post will come ready to assemble at 46")

Gates can be cut down to fit smaller widths by cutting the top and bottom rail as well as the top and bottom aluminum tubing. The vinyl T&G pickets can also be 'ripped' on a table saw to fit the opening.

To do this, cut the vinyl pocket rail to 3.5" shorter than desired gate width and the aluminum top and bottom tubing to 3.25" shorter than desired gate width.

Example – for a 34" wide gate (that would fit a 36" opening), the vinyl top and bottom pocket rails would be cut to 30.5" long. The aluminum tube top and bottom inserts would be cut to 30.75" long.

Accessories

GATE-IN-A-BOX KIT

AVAILABLE SIZES AND COLORS

Color	T&G Picket Type	Gate Body	Pocket Rail	Opening	Height	Part Number
White	6" T&G	58"	1.5"x5.5"	4'	5'	GT1555-47-4W-58-6
		58"	1.5"x5.5"	6'	5'	GT1555-47-6W-58-6
		58"	1.75"x8"	4'	5'	GT1758-42-4W-58-6
		58"	1.75"x8"	6'	5'	GT1758-42-6W-58-6
		70"	1.5"x5.5"	4'	6'	GT1555-59-4W-70-6
		70"	1.5"x5.5"	6'	6'	GT1555-59-6W-70-6
		70"	1.75"x8"	4'	6'	GT1758-54-4W-70-6
	70"	1.75"x8"	6'	6'	GT1758-54-6W-70-6	
	11.3" T&G 2-Grv	58"	1.5"x5.5"	4'	5'	GT1555-47-4W-58
		58"	1.5"x5.5"	6'	5'	GT1555-47-6W-58
		58"	1.75"x8"	4'	5'	GT1758-42-4W-58
		58"	1.75"x8"	6'	5'	GT1758-42-6W-58
		70"	1.5"x5.5"	4'	6'	GT1555-59-4W-70
		70"	1.5"x5.5"	6'	6'	GT1555-59-6W-70
70"		1.75"x8"	4'	6'	GT1758-54-4W-70	
70"	1.75"x8"	6'	6'	GT1758-54-6W-70		
Tan	6" T&G	58"	1.5"x5.5"	4'	5'	GT1555-47-4T-58-6
		58"	1.5"x5.5"	6'	5'	GT1555-47-6T-58-6
		58"	1.75"x8"	4'	5'	GT1758-42-4T-58-6
		58"	1.75"x8"	6'	5'	GT1758-42-6T-58-6
		70"	1.5"x5.5"	4'	6'	GT1555-59-4T-70-6
		70"	1.5"x5.5"	6'	6'	GT1555-59-6T-70-6
		70"	1.75"x8"	4'	6'	GT1758-54-4T-70-6
	70"	1.75"x8"	6'	6'	GT1758-54-6T-70-6	
	11.3" T&G 2-Grv	58"	1.5"x5.5"	4'	5'	GT1555-47-4T-58
		58"	1.5"x5.5"	6'	5'	GT1555-47-6T-58
		58"	1.75"x8"	4'	5'	GT1758-42-4T-58
		58"	1.75"x8"	6'	5'	GT1758-42-6T-58
		70"	1.5"x5.5"	4'	6'	GT1555-59-4T-70
		70"	1.5"x5.5"	6'	6'	GT1555-59-6T-70
70"		1.75"x8"	4'	6'	GT1758-54-4T-70	
70"	1.75"x8"	6'	6'	GT1758-54-6T-70		

*Additional sizes, styles, and colors available upon request. Please contact your sales representative for more information.

Accessories

GATE-IN-A-BOX KIT

AVAILABLE SIZES AND COLORS

Color	T&G Picket Type	Gate Body	Pocket Rail	Opening	Height	Part Number
Clay	6" T&G	70"	1.5"x5.5"	4'	6'	GT1555-59-4C-70-6
		70"	1.5"x5.5"	6'	6'	GT1555-59-6C-70-6
		70"	1.75"x8"	4'	6'	GT1758-54-C4-70-6
		70"	1.75"x8"	6'	6'	GT1758-54-C6-70-6
	11.3" T&G 1-Grv	70"	1.5"x5.5"	4'	6'	GT1555-59-4C-70
		70"	1.5"x5.5"	6'	6'	GT1555-59-6C-70
		70"	1.75"x8"	4'	6'	GT1758-54-C4-70
		70"	1.75"x8"	6'	6'	GT1758-54-C6-70
Slate Gray	11.3" T&G 2-Grv	70"	1.5"x5.5"	4'	6'	GT1555-59-4G-70
		70"	1.5"x5.5"	6'	6'	GT1555-59-6G-70
		70"	1.75"x8"	4'	6'	GT1758-54-C4-70
		70"	1.75"x8"	6'	6'	GT1758-54-C6-70
Weathered Aspen	11.3" T&G 1-Grv	70"	1.5"x5.5"	4'	6'	GT1555-59-4W-W-70
		70"	1.5"x5.5"	6'	6'	GT1555-59-6W-W-70
Driftwood	11.3" T&G 1-Grv	70"	1.5"x5.5"	4'	6'	GT1555-59-4C-W-70
		70"	1.5"x5.5"	6'	6'	GT1555-59-6C-W-70
Coastal Cedar	11.3" T&G 1-Grv	70"	1.5"x5.5"	4'	6'	GT1555-59-4CC-70
		70"	1.5"x5.5"	6'	6'	GT1555-59-6CC-70
Dark Sequoia	11.3" T&G 1-Grv	70"	1.5"x5.5"	4'	6'	GT1555-59-4DS-70
		70"	1.5"x5.5"	6'	6'	GT1555-59-6DS-70
Dark Walnut	11.3" T&G 1-Grv	70"	1.5"x5.5"	4'	6'	GT1555-59-4DW-70
		70"	1.5"x5.5"	6'	6'	GT1555-59-6DW-70
Textured Tan	11.3" T&G 1-Grv	70"	1.5"x5.5"	4'	6'	GT1555-59-4T-70-E
		70"	1.5"x5.5"	6'	6'	GT1555-59-6T-70-E
Textured Clay	11.3" T&G 1-Grv	70"	1.5"x5.5"	4'	6'	GT1555-59-4C-70-E
		70"	1.5"x5.5"	6'	6'	GT1555-59-6C-70-E
Textured Driftwood	11.3" T&G 1-Grv	70"	1.5"x5.5"	4'	6'	GT1555-59-4C-W-70-E
		70"	1.5"x5.5"	6'	6'	GT1555-59-6C-W-70-E
Textured Dark Sequoia	11.3" T&G 1-Grv	70"	1.5"x5.5"	4'	6'	GT1555-59-4DS-70-E
		70"	1.5"x5.5"	6'	6'	GT1555-59-6DS-70-E

SEMI PRIVACY
in White



Color Key

pgs. 92 - 94

PICKETS	STANDARD COLORS				TIMBERLAND SERIES								
	White	Tan	Clay	Slate Gray	Weathered Aspen	Driftwood	Coastal Cedar	Dark Walnut	Dark Sequoia	Textured Tan	Textured Clay	Textured Driftwood	Textured Dark Sequoia
0.875" X 1.5" X 0.070" PICKET	X	X	X										
0.875" X 3" X 0.070" PICKET	X	X	X	X	X	X	X	X	X				
0.875" X 6" X 0.060" PICKET	X	X	X	X	X	X	X	X	X				X
1" X 1" X 0.070" PICKET	X	X	X										
1.375" X 1.375" X 0.070" PICKET	X	X	X										
1.5" X 1.5" X 0.070" PICKET	X	X	X	X									
1.75" X 1.75" X 0.070" PICKET	X	X											

POSTS	STANDARD COLORS				TIMBERLAND SERIES								
	White	Tan	Clay	Slate Gray	Weathered Aspen	Driftwood	Coastal Cedar	Dark Walnut	Dark Sequoia	Textured Tan	Textured Clay	Textured Driftwood	Textured Dark Sequoia
3.25" X 3.25" X .120" WALL POSTS	X	X											
4" X 4" X .110" WALL POSTS	X	X											
4" X 4" X .140" WALL POSTS	X	X	X	X	X	X	X	X	X				
4" X 4" X .165" WALL POSTS	X	X	X										
5" X 5" X .135" WALL POSTS	X	X	X	X	X	X	X	X	X	X	X	X	X
5" X 5" X .135" WALL POSTS 3 RAIL ROUTED POST	X	X	X	X	X	X	X	X	X	X	X	X	X
5" X 5" X .135" WALL PRIVACY POST, ROUTED FOR 1.5" X 5.5" POCKET RAIL, 59" WINDOW	X	X	X	X	X	X	X			X	X	X	
5" X 5" X .150" WALL POSTS	X	X	X	X				X	X				X
5" X 5" X .150" WALL POSTS ROUTED FOR 1.5" X 5.5"								X	X				X
5" X 5" X .250" WALL POSTS	X	X											

TIMBERLAND SERIES									STANDARD COLORS				RAILS
Textured Dark Sequoia	Textured Driftwood	Textured Clay	Textured Tan	Dark Sequoia	Dark Walnut	Coastal Cedar	Driftwood	Weathered Aspen	Slate Gray	Clay	Tan	White	
									X	X	X	X	1.75" X 3.5" X 0.100" HOLLOW RAIL
												X	2" X 3.5" X 0.090" HOLLOW RAIL
X	X	X	X	X	X	X	X	X	X	X	X	X	2" X 3.5" X 0.110" HOLLOW RAIL
											X	X	2" X 3.5" X 0.110" RIBBED RAIL
	X	X	X			X	X	X	X	X	X	X	1.5" X 5.5" X 0.080" RANCH RAIL
X				X	X						X	X	1.5" X 5.5" X 0.100" RANCH RAIL
										X	X	X	2" X 6" X 0.110" HOLLOW RAIL
											X	X	2" X 6" X 0.100" RIBBED RAIL
X	X	X	X	X	X	X	X	X	X	X	X	X	1.5" X 5.5" X 0.090" POCKET RAIL
											X	X	1.5" X 6.5" X 0.090" POCKET RAIL
												X	1.75" X 5.5" X 0.075" POCKET RAIL
										X	X	X	1.75" X 8" X 0.090" DECO POCKET RAIL
									X	X	X	X	2" X 6" X 0.090" DECO POCKET RAIL
											X	X	3.5" X 3.5" X 0.080" T-RAIL



TONGUE & GROOVE	STANDARD COLORS				TIMBERLAND SERIES								
	White	Tan	Clay	Slate Gray	Weathered Aspen	Driftwood	Coastal Cedar	Dark Walnut	Dark Sequoia	Textured Tan	Textured Clay	Textured Driftwood	Textured Dark Sequoia
0.875" X 6" T&G	X	X	X	X									
0.875" X 6" (Locking) T&G	X	X	X	X									
0.875" X 8" SINGLE GROOVE T&G	X	X	X										
0.875" X 11.3" SINGLE GROOVE T&G	X	X	X		X	X	X	X	X	X	X	X	X
0.875" X 11.3" DOUBLE GROOVE T&G	X	X	X	X									
0.875" X 11.3" DOUBLE GROOVE (Locking)	X	X											

U-CHANNEL	STANDARD COLORS				TIMBERLAND SERIES								
	White	Tan	Clay	Slate Gray	Weathered Aspen	Driftwood	Coastal Cedar	Dark Walnut	Dark Sequoia	Textured Tan	Textured Clay	Textured Driftwood	Textured Dark Sequoia
STANDARD U-CHANNEL	X	X	X	X	X	X	X	X	X				

PRIVACY
in Tan





For more information visit us at
NVPFENCE.COM